

ströher
Faszination aus Ton.



The range 23/24

The range
23/24

SIGNATURE CERAMICS AND CLINKER.
THE STRÖHER GROUP.

ströher
Faszination aus Ton.

Lifestyle in tiles.
GEPADI

**STRÖHER
LIVING**



Our
BRANDS are a
PROMISE
to our customers.

A promise of:

**QUALITY,
CONSISTENCY,
COMPETENCE,
RELIABILITY,
SUSTAINABILITY,
DESIGN and
INNOVATION.**



On the floor.
And on the wall.
**CLAY-
MAZING.**
Outdoors and indoors.



We are constantly pushing the supposed limits of what is possible to resource-conserving, extraordinary architectural products made of clay that sustainably accentuate facades and floors, both indoors and outdoors, clay-mazing.

Stylish clinker brick slips for thermally insulated facades, frost-resistant and durable outdoor tiles for balconies and terraces, and contemporary lifestyle tiles for energy-efficient living.

Ströher delivers an outstanding quality in ceramic and clinker-performance that will win you over with its sustainability. Not only in design and visual effect, but also in its energy-related application.

For a sustainable facade and surface design.

Made in Germany.
**FASCINATION
MADE OF
CLAY.**
Since 1884.

We combined our traditional manufacturing expertise with state-of-the-art clinker ceramics engineering and cutting-edge surface coating technologies. Using a wide variety of compositions of over 50 quality clays, we create natural products fired in shape and design, which we cut from a moist, malleable clay bar and then high-performance sinter in high-temperature firing. Sustainably and energy-efficiently, needless to mention. We rely on natural ingredients and reactions, which we use with great flair and experience in a purposeful approach to achieve unique surfaces and fascinatingly natural color spectra.

For a natural premium product.

Go for green:
**RESOURCE-
SAVING AND
ENERGY-
EFFICIENT**
manufacturing.

As an energy-intensive production company, we assume responsibility for climate protection and the energy turnaround in Germany. Therefore, we have committed ourselves to ecologically compatible and sustainable manufacturing processes.

Our tiles and clinker brick slips are manufactured exclusively in modern and efficient production facilities. High energy efficiency, the use of state-of-the-art waste gas purification systems for reduced emissions, and the resource-conserving use of natural raw materials obtained in proximity to our manufacturing facilities are integral components of our active environmental and production management.

Residues from the production process of our ceramics, such as firing and drying residues, glaze residues or water, are entirely recycled and returned to the production cycle as secondary raw materials. Waste heat from the firing process is used to dry the ceramics in the upstream manufacturing process. Throughout the company, we rely 100% on green power from alternative and renewable energy sources.

A large part of this is generated by our own photovoltaic system.

The Ströher Group's active energy management is certified in accordance with DIN EN ISO 50001. Energy efficiency is thus an integral part of investment decisions and a key evaluation and decision-making criterion in the procurement of raw materials, products, services or machinery and equipment.

We have been testifying the sustainability of our products since 2011 with the IBU seal of the Institute for Building and the Environment, which stands for the highest possible neutrality and credibility as an independent eco-label. Our declared goal is to enable and promote sustainable construction.

For the sustainable use of our resources. For maximum energy efficiency in the manufacturing processes of our products.



DIN EN 50001
Energy Management

INDEX

24

NEW Roccia Next



80

NEW Origin Wood 20



94

NEW Absolute

76

NEW Absolute 20



98

NEW Color Brix

ABOUT US**4**

Our brand promise	4
Emphasise sustainably	6
Fascination made of clay	8
Resource conservation and sustainability	10

Outdoor**BALCONY AND TERRACE TILES****16**

NEW Roccia Next	24
Selected	28
Gravel Blend	32
Epos	36
Aera	40
Roccia	48
Terra	54
Retro	58
Cavar	62
Processing instructions	66

Outdoor**GARDEN AND TERRACE SLABS****70**

NEW Absolute 20	76
NEW Origin Wood 20	80
Processing instructions	84

**Contemporary Ceramic Culture****LIVING CERAMICS****88**

Energy efficiency with tiles	92
NEW Absolute	94
NEW Color Brix	98
UPDATE Origin Wood	104
Boost	108

Project**INDUSTRIAL FLOORINGS****112**

Stalotec®	114
-----------	-----

INDEX

138**UPDATE** Wasserbrand**126**Nuancist **NEW****144****UPDATE** Kontur

132**NEW** Farbklang**154**
Riegel 50

Facade

CLINKER BRICK SLIPS**118**

NEW	Nuancist	126
NEW	Farbklang	132
UPDATE	Wasserbrand	138
UPDATE	Kontur	144
	Brickwerk	150
	Riegel 50	154
	Steinlinge	158
	Glanzstücke	162
	Zeitlos	166
	Keravette®	172
	Processing instructions	176

INFORMATION**180**

General requirements and tests	180
Sales National	182
Sales International	184



Outdoor functional ceramics

BALCONY AND TERRACE TILES

ROCCIA NEXT **24**
SELECTED **28**
GRAVEL BLEND **32**
EPOS **36**
AERA **40**
ROCCIA **48**
TERRA **54**
RETRO **58**
CAVAR **62**
PROCESSING
INSTRUCTIONS **66**

Outdoor functional ceramics:

For small AREAS with special REQUIREMENTS.

A place of longing with nine letters: balconies. From chilling to barbecuing – the benefits of summer can be enjoyed perfectly, even in a small space.

When looking for an easy-care and durable balcony covering, there is no way around extruded glazed ceramics. Professional and fixed laying reveals all its talents. The formats 30 x 30 cm, 30 x 45 cm or 30 x 60 cm are easy to handle and can also conventionally be installed fixed. Very easy according to the standard, without complicated accessories and too much effort. With matching ceramic edge finish.

Because on small surfaces and especially in renovations, permanent installation with small formats is often easier than you think and, above all, lasting. This means it is sustainable.

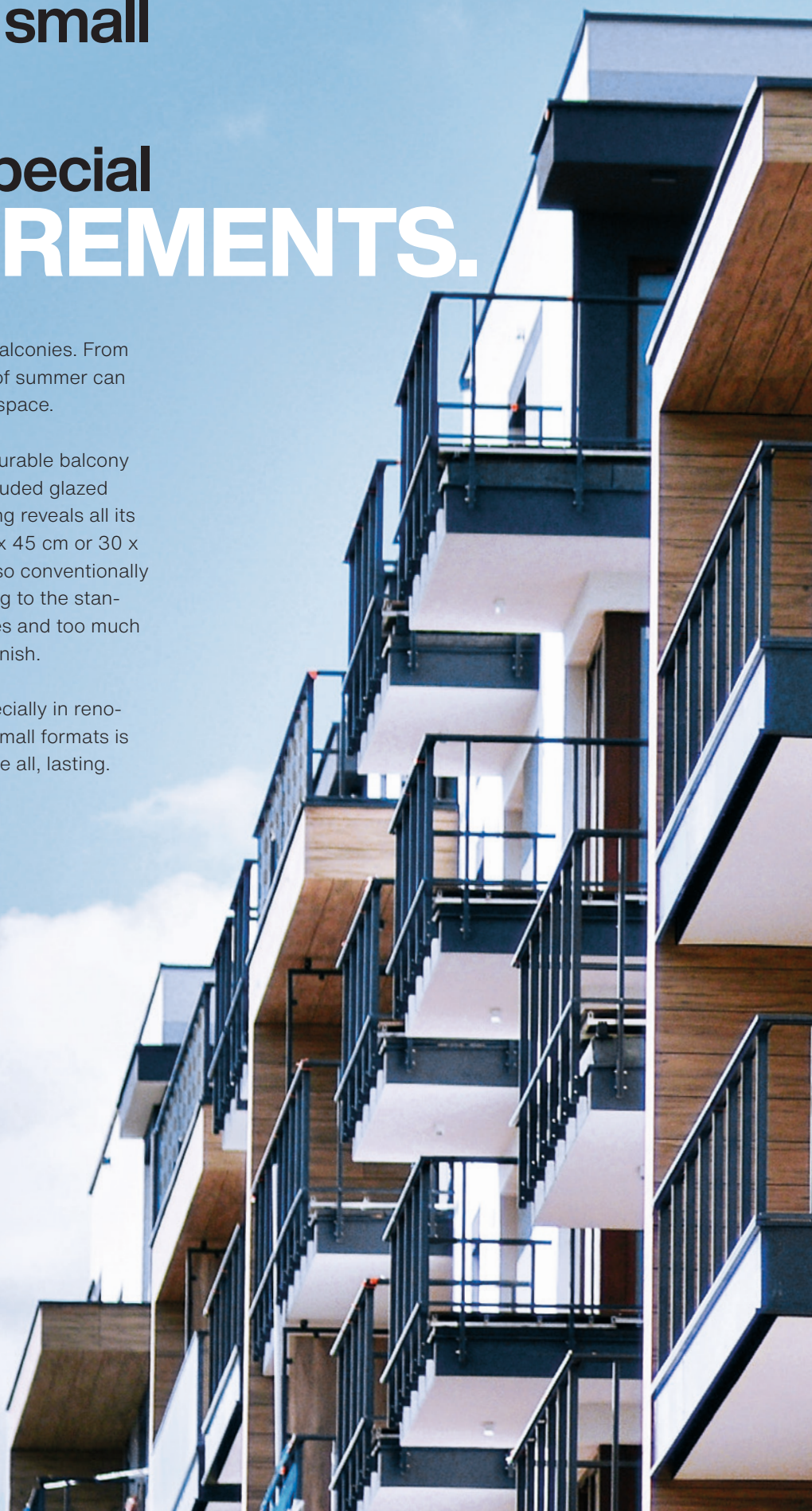



Outdoor functional ceramics:

SAFE AND DURABLE

permanently installed
**ON YOUR BALCONY.
AND TERRACE.**





**Outdoor functional ceramics with ideal adhesive qualities:
Durably safe and easy to care.**

An application concept with matching heavy clay ceramics. From the tile to the step to the edge finish: installation safety, frost resistance and diversity of shapes. Perfection in application from a single source for securely installed and durably surfaces, stairs and finishes in outdoor areas. From the classic split tile to a 30 x 60 cm format. From the innovative balcony edge loft angle tile to the straight-lined loft stair tread tile or loft corner: These are modern, mature and proven ceramic solutions in concept. Especially for balconies and terraces.

Extruded from moist clay, the strongly structured back surface of the coarse ceramic enables optimum interlocking qualities with the substrate and thus optimum adhesive pull strength. Additionally, a „weatherproof“ pore structure with breathable capillary channels and a draining, homogeneous particle structure is created in the ceramic shard. Even the smallest amount of condensation water can thus escape naturally. It's what we call the membrane effect.

We rely on specifically developed, resistant hard glazes based on high-grade mineral raw materials for our ceramics. Not only does this ensure greater slip resistance in wet conditions, it also provides for consistent ease of use and care.



For perfect frost resistance and installation safety: OUTDOOR FUNCTIONALITY IN DETAIL



Outdoor
functional ceramics



Frost resistance
25 year guarantee*



Mechanical
adhesive qualities
for a safe and per-
manent bonding.



Ideal for renova-
tions of balconies,
terraces and
outdoor stairs.



For a perfect floor
concept.
Stairs, steps and
edge finishes.



Sustainable
building material.



Energy-efficiently
manufactured.

IDEAL TENSILE ADHESION PROPERTIES

The marked structure of the reverse side that comes from the production process, in which wet clay is extruded to produce coarse ceramics, allows for optimal contact with the substrate and therefore the best possible tensile adhesion. (REM image at 500 x magnification – direct plan view).

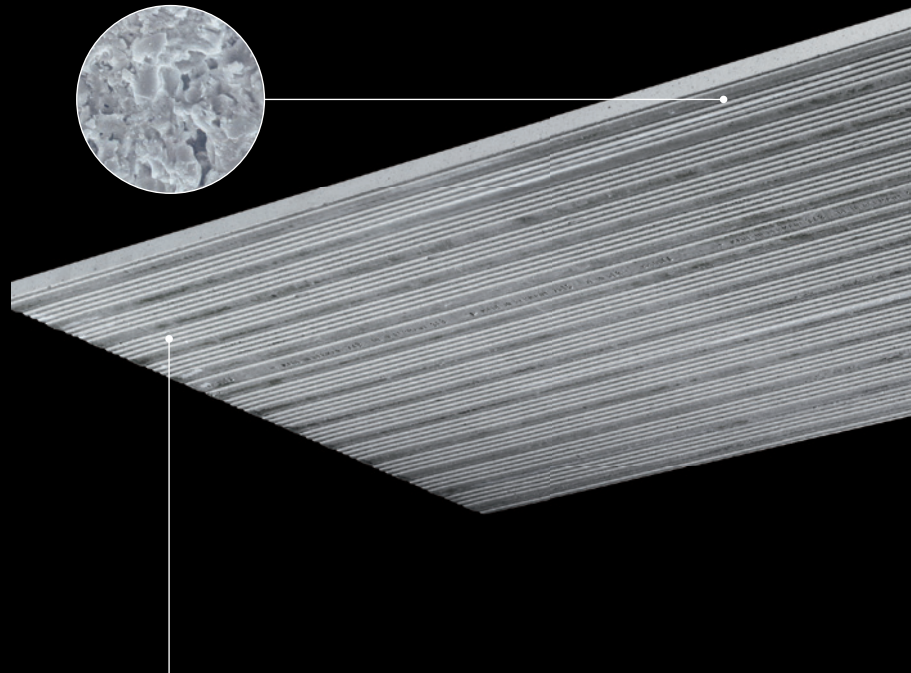
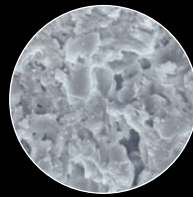

On selected products:
Frost resistance
25 year guarantee*

* Ströher grants a 25-year guarantee on frost resistance for the following selected coarse ceramic products and series when laid professionally by a qualified specialist company: Roccia Next, Selected, Gravel Blend, Epos, Aera, Roccia, Terra, Stalotec, Farbklang, Nuancist, Brickwerk, Wasserbrand, Kontur, Riegel 50, Steinlinge, Glanzstücke, Zeitlos und Keravette.

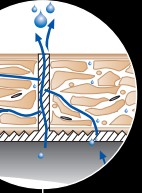

FUNCTIONALLY ENHANCED CERAMIC WITH MEMBRANE EFFECT

Thanks to the manufacturing method using extrusion, Ströher ceramics have a 'weather-proof' pore structure involving capillary channels that allow the material to 'breathe' as well as a homogeneous particulate structure that promotes drainage. Even the smallest amount of condensation can escape naturally. We call this the membrane effect.



VARIETY OF TRIM PIECES

From the innovative balcony edge loft angle tile to the straight-lined loft stair tread tile or loft corner: These are modern, mature and proven ceramic solutions in concept. Especially for balconies and terraces.

STRÖHER HARDGLAZE 2.0 AND 3.0

The next development in Ströher's hard glaze technology provides better anti-slip safety in wet conditions – still with the same ease of use and cleaning.



F+P Fliesen und Platten
Produkt des Jahres 2022
2. Platz in der Kategorie Fliesen und Platten

30 x 60 cm ROCCIA NEXT greige

ROCCIA NEXT NEW

The new coarse ceramic that doesn't look it.

The clear aesthetics of the new generation.

The generic term for outdoor ceramics, with which a rich and fascinating journey of coarse ceramics' evolution began 25 years ago, is starting a new chapter – in a new generation: In a clear aesthetic, in a combination of natural stone effects and in a unique surface, a new, very personal style of modern outdoor ceramics was created. This is Roccia Next. Mineral look, in three colour variations, two formats and with matching loft moulding range.

A new coarse ceramic outdoor concept with which we are embarking on a contemporary path. With elegance and beauty and including the usual application safety and concept comfort. Because extruded ceramic shards ensure maximum outdoor durability when laid professionally.

ROCCIANEXT NEW



Natural. Aesthetic. Functional.

Colours



2573 light grey



2514 greige



2542 taupe



Completely frost resistant
25 year guarantee*



Stroher
hard glaze



Variety of
trim pieces



Fade-free and
colourfast



Easy maintenance
and hygienic



PEI 5 Abrasion
resistant



Anti-slip



In compliance
with DIN EN



Variety of
accessories



Ecofriendly



Resistant to
chemicals



Glow-resistant
and fireproof



Anti-static



Outdoor functional ceramics



Frost resistance 25 year guarantee*



Mechanical adhesive qualities for a safe and permanent bonding.



Ideal for renovations of balconies, terraces and outdoor stairs.



For a perfect floor concept. Stairs, steps and edge finishes.



Sustainable building material.



Energy-efficiently manufactured.

ROCCIANEXT product details

DIN EN 14411
stoneware tile, extruded
test result precision



EXTRUDED STONEWARE TILE

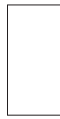

EXTRUDED STONEWARE TILE



LOFT ANGLE TILE ²⁾



LOFT STAIR TREAD TILE ^{2) 3)}



SKIRTING



RISER CORNER

NOMINAL SIZE IN CM	30 x 30		30 x 60		30		30		30		-	
PRODUCTION SIZE IN MM	294 x 294 x 10		294 x 594 x 10		294 x 175 x 52 x 10		294 x 340 x 35 x 11		294 x 70 x 10		157 x 52 x 52 x 10	
SLIP RESISTANCE	R 10/A		R 10/A		R 10/A		R 10/A		-		-	
LOAD GROUP	5		5		5		5		-		-	
CALIBRATED	no		yes		no		yes		no		yes	
COLOUR	PG	ARTICLE	PG	ARTICLE	PG	ARTICLE	PG	ARTICLE	PG	ARTICLE	PG	ARTICLE
2573 LIGHT GREY		95062-002		95062-005		95062-008		95062-011		95062-014		95062-017
2514 GREIGE	7	95062-003	8	95062-006	675	95062-009	967	95062-012	55	95062-015	80	95062-018
2542 TAUPE		95062-004		95062-007		95062-010		95062-013		95062-016		95062-019
PIECE	kg	1,706	3,754		1,526		2,740		0,421		0,400	
	Piece	11	6		6		4		16		2	
BUNDLE	m ² /lm	1,00	1,09		1,82		1,21		4,85		-	
	kg	18,766	22,524		9,156		10,960		6,736		0,800	
PALLET	Piece	572	240		192		100		2.880		1.704	
	m ² /lm	52,00	43,64		58,18		30,30		872,73		-	
	kg	976	901		293		274		1.212		682	
	Bundle	52	40		32		25		180		852	
M ² /LM	Piece (incl. joint)	11,00	5,50		3,30		3,30		3,30		-	
	kg	18,766	20,647		5,036		9,042		1,389		-	
DISCOUNT ON PALLETS	yes		yes		yes		yes		no		no	
SURCHARGE ¹⁾	yes		yes		yes		no		yes		no	

PG = Price group (please see price list 2023) ¹⁾ = Minimum quantity; each open box will incur a surcharge. ²⁾ = The marked trim pieces are to be used in accordance with the applicable instructions for use from Ströher GmbH as well as applicable standards and informational leaflets. For further information please see catalogue page 66 or visit our website under www.stroeher.de. ³⁾ = The 340 mm tread depth of the loft stair tread corner and tread tile allows flexible use and adjustment, even for non-standard stairs.

The formats shown are illustrative drawings and are not binding. All information without guarantee.

* Ströher grants a 25-year guarantee on frost resistance for the following selected coarse ceramic products and series when laid professionally by a qualified specialist company: Roccia Next, Selected, Gravel Blend, Epos, Aera, Roccia, Terra, Stalotec, Farbklang, Nuancist, Brickwerk, Wasserbrand, Kontur, Riegel 50, Steinlinge, Glanzstücke, Zeitlos und Keravette.



F+P Fliesen und Platten
Produkt des Jahres 2020
2. Platz in der Kategorie Fliesen

30 x 60 cm SELECTED grey with 30 x 30 cm SELECTED Decor

SELECTED

**Retro modern mix exposed concrete.
For a highly versatile and user-friendly surface.**

Contemporary décor ceramic tiling.

Opposites that attract: urban style and vintage romanticism. Selected combines the minimalist elegance of exposed concrete with fine geometrical or floral elements. The result is a new type of outdoor urban style: understated, yet comfortably warm. Discreet, yet deliberately expressive.

Selected allows for individual freedom of choice using three warm colour shades and the formats 30 x 60 calibrated and 30 x 30 cm. As well as decorative elements with various, random designs and layouts. Naturally, Selected has all the attributes of Ströher paving in terms of safety and comfort of use – including solutions for ceramic steps and edges. A extruded ceramic body, with fixed laying by professionals, results in maximum toughness for outdoor use.

SELECTED

Contemporary. Retro modern. Functional.



Colours



4673 grey



4612 greige



4684 anthracite



4691 decor



Completely frost resistant
25 year guarantee*



Stroher
hard glaze



Variety of
trim pieces



Fade-free and
colourfast



Easy maintenance
and hygienic



PEI 5 Abrasion
resistant



Anti-slip



In compliance
with DIN EN



Variety of
accessories



Ecofriendly



Resistant to
chemicals



Glow-resistant
and fireproof



Anti-static



Outdoor functional ceramics



Frost resistance 25 year guarantee*



Mechanical adhesive qualities for a safe and permanent bonding.



Ideal for renovations of balconies, terraces and outdoor stairs.



For a perfect floor concept. Stairs, steps and edge finishes.



Sustainable building material.



Energy-efficiently manufactured.

SELECTED product details

DIN EN 14411
stoneware tile, extruded
test result precision



EXTRUDED STONEWARE TILE

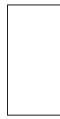

EXTRUDED STONEWARE TILE



LOFT ANGLE TILE ²⁾



LOFT STAIR TREAD TILE ^{2) 3)}

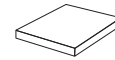

LOFT STAIR TREAD CORNER ^{2) 3)}



SKIRTING



RISER CORNER

NOMINAL SIZE IN CM	30 x 30	30 x 60	30	30	30	30	-							
PRODUCTION SIZE IN MM	294 x 294 x 10	294 x 594 x 10	294 x 175 x 52 x 10	294 x 340 x 35 x 11	340 x 340 x 35 x 11	294 x 70 x 10	157 x 52 x 52 x 10							
SLIP RESISTANCE	R 10/A	R 10/A	R 10/A	R 10/A	R 10/A	-	-							
LOAD GROUP	5	5	5	5	5	-	-							
CALIBRATED	no	yes	no	yes	yes	no	yes							
COLOUR	PG	ARTICLE	PG	ARTICLE	PG	ARTICLE	PG	ARTICLE	PG	ARTICLE				
4673 GREY		95053-002		95053-006		95053-009		95053-012		95053-015		95053-021		95053-024
4612 GREIGE	12	95053-003	414	95053-007	675	95053-010	967	95053-013	113	95053-016	55	95053-022	80	95053-025
4684 ANTHRACITE		95053-004		95053-008		95053-011		95053-014		95053-017		95053-023		95053-026
4691 DECOR	22	95053-005												
PIECE	kg	1,706	3,754	1,526	2,740	3,718	0,421	0,400						
	Piece	11	6	6	4	1	16	2						
BUNDLE	m ² /lm	1,00	1,09	1,82	1,21	-	4,85	-						
	kg	18,766	22,524	9,156	10,960	3,718	6,736	0,800						
PALLET	Piece	572	240	192	100	78	2,880	1,704						
	m ² /lm	52,00	43,64	58,18	30,30	-	872,73	-						
	kg	976	901	293	274	290	1,212	682						
	Bundle	52	40	32	25	78	180	852						
M ² /LM	Piece (incl. joint)	11,00	5,50	3,30	3,30	-	3,30	-						
	kg	18,766	20,647	5,036	9,042	-	1,389	-						
DISCOUNT ON PALLETS		yes	yes	yes	yes	no	no	no						
SURCHARGE ¹⁾		yes	yes	yes	no	no	yes	no						

PG = Price group (please see price list 2023) ¹⁾ = Minimum quantity: each open box will incur a surcharge. ²⁾ = The marked trim pieces are to be used in accordance with the applicable instructions for use from Ströher GmbH as well as applicable standards and informational leaflets. For further information please see catalogue page 66 or visit our website under www.stroeh.de ³⁾ = The 340 mm tread depth of the loft stair tread corner and tread tile allows flexible use and adjustment, even for non-standard stairs.

The formats shown are illustrative drawings and are not binding. All information without guarantee.

* Ströher grants a 25-year guarantee on frost resistance for the following selected coarse ceramic products and series when laid professionally by a qualified specialist company: Roccia Next, Selected, Gravel Blend, Epos, Aera, Roccia, Terra, Stalotec, Farbklang, Nuancist, Brickwerk, Wasserbrand, Kontur, Riegel 50, Steinlinge, Glanzstücke, Zeitlos und Keravette.



30 x 60 cm GRAVEL BLEND taupe with loft stair tread tile

GRAVEL BLEND

**Fine grained matrix.
Coarse grained ease of cleaning.**

**Round rolled pebbles. Extruded clay.
For the antique look with function.**

Gravel Blend's surface finish is modelled on conglomerate rock with a fine-grained matrix and river-pebble inclusions. It is a naturally occurring type of stone that has formed over the course of millions of years since the Alps began to take shape.

Gravel Blend is also created by means of a classic 'baking' process, which makes ceramics very resistant. This is known as 'extrusion' of moist raw clay. Fired using the most modern furnace technology, Gravel Blend combines the primeval appearance of 'conglomerate' with the utility of an easy-maintenance, non-slip outdoor surface. Modern, frost resistant and durable.

GRAVEL BLEND

Trendy. Archaic. Extruded.



Colours



3615 beige



3675 grey



3648 taupe



3687 black



3644 brown



Completely frost resistant
25 year guarantee*



Ströher
hard glaze



Variety of
trim pieces



Fade-free and
colourfast



Easy maintenance
and hygienic



PEI 5 Abrasion
resistant



R 10/A
Anti-slip



In compliance
with DIN EN



Variety of
accessories



Ecofriendly



Resistant to
chemicals



Glow-resistant
and fireproof



Anti-static



Outdoor functional ceramics



Frost resistance 25 year guarantee*



Mechanical adhesive qualities for a safe and permanent bonding.



Ideal for renovations of balconies, terraces and outdoor stairs.



For a perfect floor concept. Stairs, steps and edge finishes.



Sustainable building material.



Energy-efficiently manufactured.

GRAVEL BLEND product details

DIN EN 14411
stoneware tile, extruded
test result precision



EXTRUDED STONWARE TILE

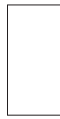

EXTRUDED STONWARE TILE



LOFT ANGLE TILE ²⁾



LOFT STAIR TREAD TILE ^{2) 3)}

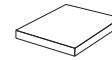

LOFT STAIR TREAD CORNER ^{2) 3)}



SKIRTING



RISER CORNER

NOMINAL SIZE IN CM	30 x 30	30 x 60	30	30	30	30	-									
PRODUCTION SIZE IN MM	294 x 294 x 10	294 x 594 x 10	294 x 175 x 52 x 10	294 x 340 x 35 x 11	340 x 340 x 35 x 11	294 x 70 x 10	157 x 52 x 52 x 10									
SLIP RESISTANCE	R 10/A	R 10/A	R 10/A	R 10/A	R 10/A	-	-									
LOAD GROUP	5 ⁴⁾	5 ⁴⁾	5 ⁴⁾	5 ⁴⁾	5 ⁴⁾	-	-									
CALIBRATED	no	yes	no	yes	yes	no	yes									
COLOUR	PG	ARTICLE	PG	ARTICLE	PG	ARTICLE	PG	ARTICLE	PG	ARTICLE						
	3615	BEIGE	12	95040-002	414	95040-007	675	95040-012	967	95040-022	113	95040-027	55	95040-037	80	95040-042
	3644	BROWN		95040-003		95040-008		95040-013		95040-023		95040-028		95040-038		95040-043
	3675	GREY		95040-004		95040-009		95040-014		95040-024		95040-029		95040-039		95040-044
	3687	BLACK ⁴⁾		95040-005		95040-010		95040-015		95040-025		95040-030		95040-040		95040-045
	3648	TAUPE		95040-006		95040-011		95040-016		95040-026		95040-031		95040-041		95040-046
PIECE	kg	1,706	3,754	1,526	2,740	3,718	0,421	0,400								
	Piece	11	6	6	4	1	16	2								
BUNDLE	m ² /lm	1,00	1,09	1,82	1,21	-	4,85	-								
	kg	18,766	22,524	9,156	10,960	3,718	6,736	0,800								
PALLET	Piece	572	240	192	100	78	2,880	1,704								
	m ² /lm	52,00	43,64	58,18	30,30	-	872,73	-								
	kg	976	901	293	274	290	1,212	682								
	Bundle	52	40	32	25	78	180	852								
M ² /LM	Piece (incl. joint)	11,00	5,50	3,30	3,30	-	3,30	-								
	kg	18,766	20,647	5,036	9,042	-	1,389	-								
DISCOUNT ON PALLETS		yes	yes	yes	yes	no	no	no								
SURCHARGE ¹⁾		yes	yes	yes	no	no	yes	no								

PG = Price group (please see price list 2023) ¹⁾ = Minimum quantity: each open box will incur a surcharge. ²⁾ = The marked trim pieces are to be used in accordance with the applicable instructions for use from Ströher GmbH as well as applicable standards and informational leaflets. For further information please see catalogue page 66 or visit our website under www.stroehher.de ³⁾ = The 340 mm tread depth of the loft stair tread corner and tread tile allows flexible use and adjustment, even for non-standard stairs.

⁴⁾ = Colour 3687 black meets loadgroup 4.

The formats shown are illustrative drawings and are not binding. All information without guarantee.

* Ströher grants a 25-year guarantee on frost resistance for the following selected coarse ceramic products and series when laid professionally by a qualified specialist company: Roccia Next, Selected, Gravel Blend, Epos, Aera, Roccia, Terra, Stalotec, Farbklang, Nuancist, Brickwerk, Wasserbrand, Kontur, Riegel 50, Steinlinge, Glanzstücke, Zeitlos und Keravette.



30 x 45 cm EPOS eres with loft stair tread tile and loft stair tread corner

EPOS

**Keeps promises.
Extruded natural stone ceramic.**

**Natural stone in design and feel.
As usual easy to clean, frost resistant and outdoor functional.**

Epos is the easy-to-use solution for an environmentally friendly, easy-clean and reliable stone floor effect. Distinctive natural stone ceramic – processed with care; made possible by means of state-of-the-art digital printing technology that does not produce a ‘transfer’ look that is otherwise common with digital printing.

This is where the ‘look’ and the ‘feel’ produce a special impression together. Thanks to Hardglaze 3.0, developed especially for digital printing, you have to look very hard – or feel very carefully – to detect that it isn’t really natural stone. And that is combined with the typical hard glaze extra-easy cleaning characteristics.



Outdoor functional ceramics



Frost resistance 25 year guarantee*



Mechanical adhesive qualities for a safe and permanent bonding.



Ideal for renovations of balconies, terraces and outdoor stairs.



For a perfect floor concept. Stairs, steps and edge finishes.



Sustainable building material.



Energy-efficiently manufactured.

EPOS product details

DIN EN 14411 stoneware tile, extruded test result precision

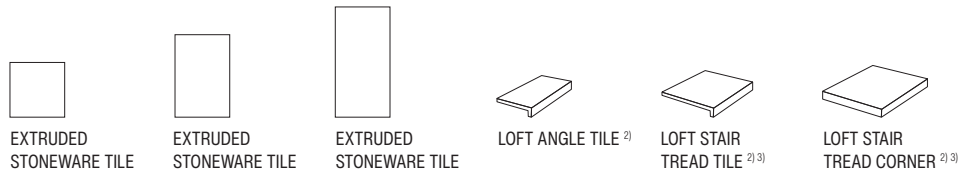

	EXTRUDED STONEWARE TILE		EXTRUDED STONEWARE TILE		EXTRUDED STONEWARE TILE		LOFT ANGLE TILE ²⁾		LOFT STAIR TREAD TILE ²⁾³⁾		LOFT STAIR TREAD CORNER ²⁾³⁾	
NOMINAL SIZE IN CM	30 x 30		30 x 45		30 x 60		30		30		30	
PRODUCTION SIZE IN MM	294 x 294 x 10		294 x 444 x 10		294 x 594 x 10		294 x 175 x 52 x 10		294 x 340 x 35 x 11		340 x 340 x 35 x 11	
SLIP RESISTANCE	R 10/A		R 10/A		R 10/A		R 10/A		R 10/A		R 10/A	
LOAD GROUP	5		5		5		5		5		5	
CALIBRATED	no		no		no		no		yes		yes	
COLOUR	PG	ARTICLE	PG	ARTICLE	PG	ARTICLE	PG	ARTICLE	PG	ARTICLE	PG	ARTICLE
2671 KRIOS	12	95028-002	367	95028-006	412	95028-010	675	95028-012	967	95028-020	113	95028-024
2676 PIDRA		95028-003		95028-007		95028-011		95028-013		95028-021		95028-025
2615 ERES		95028-004		95028-008		95028-014		95028-022		95028-026		
2644 KAWE		95028-005		95028-009		95028-015		95028-023		95028-027		
PIECE	kg	1,706	2,785	3,733	1,526	2,740	3,718					
	Piece	11	6	6	6	4	1					
BUNDLE	m ² /lm	1,00	0,81	1,09	1,82	1,21	-					
	kg	18,766	16,710	22,398	9,156	10,960	3,718					
	Piece	572	312	240	192	100	78					
PALLET	m ² /lm	52,00	42,11	43,64	58,18	30,30	-					
	kg	976	869	896	293	274	290					
	Bundle	52	52	40	32	25	78					
M ² /LM	Piece (incl. joint)	11,00	7,41	5,50	3,30	3,30	-					
	kg	18,766	20,637	20,532	5,036	9,042	-					
DISCOUNT ON PALLETS	yes		yes		yes		yes		yes		no	
SURCHARGE ¹⁾	yes		yes		yes		yes		no		no	

PG = Price group (please see price list 2023) ¹⁾ = Minimum quantity: each open box will incur a surcharge. ²⁾ = The marked trim pieces are to be used in accordance with the applicable instructions for use from Ströher GmbH as well as applicable standards and informational leaflets. For further information please see catalogue page 66 or visit our website under www.stroher.de ³⁾ = The 340 mm tread depth of the loft stair tread corner and tread tile allows flexible use and adjustment, even for non-standard stairs.

The formats shown are illustrative drawings and are not binding. All information without guarantee.

* Ströher grants a 25-year guarantee on frost resistance for the following selected coarse ceramic products and series when laid professionally by a qualified specialist company: Roccia Next, Selected, Gravel Blend, Epos, Aera, Roccia, Terra, Stalotec, Farbklang, Nuancist, Brickwerk, Wasserbrand, Kontur, Riegel 50, Steinlinge, Glanzstücke, Zeitlos und Keravette.



Completely frost resistant 25 year guarantee*



Ströher hard glaze



Variety of trim pieces



Fade-free and colourfast



Easy maintenance and hygienic



PEI 5 Abrasion resistant



R 10/A Anti-slip



In compliance with DIN EN



Variety of accessories



Ecofriendly



Resistant to chemicals



Glow-resistant and fireproof



Anti-static

EPOS



Reliable. Deceptively genuine-looking. Distinctive.

Colours



SKIRTING



RISER CORNER

30		-	
294 x 70 x 10		157 x 52 x 52 x 10	
-		-	
-		-	
no		yes	
PG	ARTICLE	PG	ARTICLE
55	95028-036	80	95028-040
	95028-037		95028-041
	95028-038		95028-042
	95028-039		95028-043
0,421	0,400		
16	2		
4,85	-		
6,736	0,800		
2.880	1.704		
872,73	-		
1.212	682		
180	852		
3,30	-		
1,389	-		
no	no		
yes	no		



2671 krios



2676 pidra



2615 eres



2644 kawę



30 x 45 cm AERA camaro with loft angle tile, loft stair tread tile and loft stair tread corner



AERA

**Confident surface impression.
Strong character expression.**

**Classic on trend floor. Easy-care stone finish.
Coarse ceramic natural stone.**

For centuries formed under tremendous pressure: That is the history of natural stone's formation. But then a new era dawned: extruded ceramic bodies with characteristic vein inlets, mineral inclusions and natural color play.

As reduced, as cozy or as elegant as the architectural style, the color choice of this flooring determines its appearance. Cool gray, strong anthracite, warm red and distinctive beige - colors with strong character that are associated with the Bauhaus, country house or mansion style trends in contemporary residential architecture.

Aera offers the typical Ströher application reliability and the usual conceptual comfort with matching ceramic stair and finishing solutions included. Because the extruded ceramic body ensures maximum outdoor durability when installed in a professional manner.



AERA

Frost-resistant. Slip-proof. Confidently stylish.

Colours



1471 baccar



1473 betone



1475 crio



1485 anthra



1414 faveo



1425 camaro



1415 pinar



30 x 45 cm AERA betone with left stair tread tile



Outdoor functional ceramics



Frost resistance
25 year guarantee*



Mechanical adhesive qualities for a safe and permanent bonding.



Ideal for renovations of balconies, terraces and outdoor stairs.



For a perfect floor concept. Stairs, steps and edge finishes.



Sustainable building material.



Energy-efficiently manufactured.

AERA product details

DIN EN 14411
stoneware tile, extruded
test result precision



EXTRUDED
STONEWARE TILE



EXTRUDED
STONEWARE TILE



EXTRUDED
STONEWARE TILE



STAIR TREAD TILE



LOFT ANGLE TILE ²⁾



LOFT STAIR
TREAD TILE ²⁾³⁾

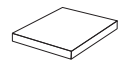

LOFT STAIR
TREAD CORNER ²⁾³⁾

NOMINAL SIZE IN CM	30 x 30	30 x 45	30 x 60	30	30	30	30			
PRODUCTION SIZE IN MM	294 x 294 x 10	294 x 444 x 10	294 x 594 x 10	294 x 300 x 10	294 x 175 x 52 x 10	294 x 340 x 35 x 11	340 x 340 x 35 x 11			
SLIP RESISTANCE	R 10/A	R 10/A	R 10/A	R 10/A	R 10/A	R 10/A	R 10/A			
LOAD GROUP	5 ⁴⁾	5 ⁴⁾	5	5 ⁴⁾	5 ⁴⁾	5 ⁴⁾	5 ⁴⁾			
CALIBRATED	no	no	no	no	no	yes	yes			
COLOUR	PG	ARTICLE	PG	ARTICLE	PG	ARTICLE	PG	ARTICLE	PG	ARTICLE
1414 FAVEO		95016-007				95016-050		95016-030		
1471 BACCAR		95016-005				95016-048		95016-028		
1485 ANTHRA ⁴⁾		95016-004		95016-014		95016-047		95016-027		95016-071
1473 BETONE	10	95016-002		95016-012	412	95016-018	60	95016-025	967	95016-069
1425 CAMARO		95016-010	365	95016-017		95016-021		95016-033		95016-072
1475 CRIO		95016-003		95016-013		95016-022		95016-026		95016-070
1415 PINAR		95016-008		95016-016		95016-020		95016-031		95016-083
										95016-081
										95016-084
										95016-082
PIECE	kg	1,706	2,785	3,733	1,727	1,526	2,740	3,718		
	Piece	11	6	6	10	6	4	1		
BUNDLE	m ² /lm	1,00	0,81	1,09	3,03	1,82	1,21	-		
	kg	18,766	16,710	22,398	17,270	9,156	10,960	3,718		
PALLET	Piece	572	312	240	520	192	100	78		
	m ² /lm	52,00	42,11	43,64	157,58	58,18	30,30	-		
	kg	976	869	896	898	293	274	290		
	Bundle	52	52	40	52	32	25	78		
M ² /LM	Piece (incl. joint)	11,00	7,41	5,50	3,30	3,30	3,30	-		
	kg	18,766	20,637	20,532	5,699	5,036	9,042	-		
DISCOUNT ON PALLETS	yes	yes	yes	yes	yes	yes	yes	no		
SURCHARGE ¹⁾	yes	yes	yes	yes	yes	yes	no	no		

PG = Price group (please see price list 2023) ¹⁾ = Minimum quantity: each open box will incur a surcharge. ²⁾ = The marked trim pieces are to be used in accordance with the applicable instructions for use from Ströher GmbH as well as applicable standards and informational leaflets. For further information please see catalogue page 66 or visit our website under www.stroehher.de ³⁾ = The 340 mm tread depth of the loft stair tread corner and tread tile allows flexible use and adjustment, even for non-standard stairs.

⁴⁾ = Colour 1485 anthra meets loadgroup 4.

The formats shown are illustrative drawings and are not binding. All information without guarantee.

* Ströher grants a 25-year guarantee on frost resistance for the following selected coarse ceramic products and series when laid professionally by a qualified specialist company: Roccia Next, Selected, Gravel Blend, Epos, Aera, Roccia, Terra, Stalotec, Farbklang, Nuancist, Brickwerk, Wasserbrand, Kontur, Riegel 50, Steinlinge, Glanzstücke, Zeitlos und Keravette.



STAIR TREAD TILE		STAIR TREAD CORNER		SKIRTING		RISER CORNER		STAIR SKIRTING LEFT		STAIR SKIRTING RIGHT	
30		30		30		-		-		-	
294 x 340 x 12		345 x 345 x 12		294 x 70 x 10		157 x 52 x 52 x 10		294 x 70 x 10		294 x 70 x 10	
R 10/A		R 10/A		-		-		-		-	
5		5		-		-		-		-	
no		no		no		yes		no		no	
PG	ARTICLE	PG	ARTICLE	PG	ARTICLE	PG	ARTICLE	PG	ARTICLE	PG	ARTICLE
95	95016-064	105	95016-076	55	95016-111	80	95016-165	1225	95016-117	1225	95016-122
	95016-062		95016-074		95016-110		95016-163		95016-116		95016-121
					95016-109		95016-162				
95	95016-067	105	95016-079	55	95016-114	80	95016-168	1225	95016-119	1225	95016-124
	95016-061		95016-073		95016-108		95016-161		95016-115		95016-120
	95016-065		95016-077		95016-112		95016-166		95016-118		95016-123
3,006		4,372		0,421		0,400		0,682		0,682	
4		1		16		2		8		8	
1,21		-		4,85		-		-		-	
12,024		4,372		6,736		0,800		5,456		5,456	
160		78		2.880		1.704		-		-	
48,48		-		872,73		-		-		-	
481		341		1.212		682		-		-	
40		78		180		852		-		-	
3,30		-		3,30		-		-		-	
9,920		-		1,389		-		-		-	
yes		no		no		no		no		no	
no		no		yes		no		no		no	



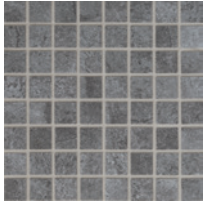

95016-180
Mosaic surface 1475 crio

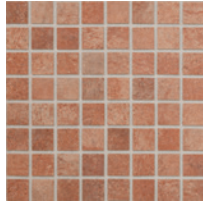

95016-181
Mosaic surface 1425 camaro



95016-186
Mosaic surface
1425 multicoloured



95016-173 with 95016-175
AERA border II with corner piece
Aera border II

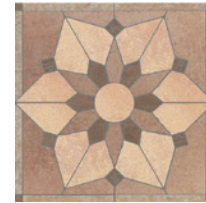

95016-172
Inlay Fiora

AERA product details

DIN EN 14411
stoneware tile, extruded
test result precision



AERA BORDER II



CORNER PIECE
AERA BORDER II



INLAY FIORA



MOSAIC
SURFACE

NOMINAL SIZE IN CM	30	-	60	30 x 30 (2,5 x 2,5)
PRODUCTION SIZE IN MM	294 x 72 x 10	72 x 72 x 10	594 x 594 x 10	294 x 294 x 10
SLIP RESISTANCE	R 10/A	R 10/A	R 10/A	R 10/B
LOAD GROUP	5	5	5	5 ²⁾
CALIBRATED	no	no	no	no
COLOUR	PG	ARTICLE	PG	ARTICLE
● 1485 ANTHRA ²⁾				95016-182
● 1473 BETONE				95016-183
● 1425 CAMARO				95016-181
● 1475 CRIO				95016-180
● 1415 PINAR				95016-187
● 1494 BORDER II	83	95016-173	86	95016-175
● 1493 FIORA			1188	95016-172
● 1495 MULTICOLOURED				95016-186
PIECE	kg	0,400	0,200	7,600
	Piece	1	1	11
BUNDLE	m ² /lm	0,30	-	-
	kg	0,400	0,200	7,600
	Piece	-	-	-
	m ² /lm	-	-	-
PALLET	kg	-	-	-
	Bundle	-	-	-
	Piece (incl. joint)	3,30	-	-
M ² /LM	kg	1,320	-	-
DISCOUNT ON PALLETS	no	no	no	no
SURCHARGE ¹⁾	no	no	no	yes

PG = Price group (please see price list 2023) ¹⁾ = Minimum quantity: each open box will incur a surcharge. ²⁾ = Colour 1485 anthra meets loadgroup 4.

The formats shown are illustrative drawings and are not binding. All information without guarantee.

* Ströher grants a 25-year guarantee on frost resistance for the following selected coarse ceramic products and series when laid professionally by a qualified specialist company: Roccia Next, Selected, Gravel Blend, Epos, Aera, Roccia, Terra, Stalotec, Farbklang, Nuancist, Brickwerk, Wasserbrand, Kontur, Riegel 50, Steinlinge, Glanzstücke, Zeitlos und Keravette.



30 x 60 cm AERA crio with skirting



30 x 30 cm ROCCIA marmos with stair tread tile

ROCCIA

**Relief-stressed, rock-like structure.
Ströher evergreens and classics.**

Functional balcony surfacing as a generic term for
'Outdoor Ceramics'.

Every success story is driven by a certain phenomenon. By the stroke of fortune of having the right idea and putting it professionally into practice at exactly the right time – and not just once.

This classic product is the realisation of an idea that timelessly encompasses the zeitgeist. A Mediterranean surface structure combined with the product benefits of genuine coarse ceramic material. Frost resistance and trim pieces variety with a relief-stressed, rock-like structure. Summer flair that can withstand the winter; winter hardness with the flair of summer. For outside and inside.

ROCCIA

Frost resistant. Anti-slip. Relief-stressed.



Colours



1317 corda



1372 marmos



1313 sandos



1376 grigio



1323 rosso



1386 nero



Completely frost resistant
25 year guarantee*



Stroher
hard glaze



Variety of
trim pieces



Fade-free and
colourfast



Easy maintenance
and hygienic



PEI 5 Abrasion
resistant



R 10/A
Anti-slip



In compliance
with DIN EN



Variety of
accessories



Ecofriendly



Resistant to
chemicals



Glow-resistant
and fireproof



Anti-static



30 x 30 cm ROCCIA rosso with stair tread tile



Outdoor functional ceramics



Frost resistance 25 year guarantee*



Mechanical adhesive qualities for a safe and permanent bonding.



Ideal for renovations of balconies, terraces and outdoor stairs.



For a perfect floor concept. Stairs, steps and edge finishes.



Sustainable building material.



Energy-efficiently manufactured.

ROCCIA product details

DIN EN 14411
stoneware tile, extruded
test result precision



EXTRUDED STONEWARE TILE



STAIR TREAD TILE



LOFT ANGLE TILE ²⁾



STAIR TREAD TILE

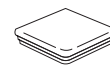

STAIR TREAD CORNER



SKIRTING



RISER CORNER

NOMINAL SIZE IN CM	30 x 30		30		30		30		30		-			
PRODUCTION SIZE IN MM	294 x 294 x 10		294 x 300 x 10		294 x 175 x 52 x 10		294 x 340 x 12		345 x 345 x 12		294 x 70 x 10		157 x 52 x 52 x 10	
SLIP RESISTANCE	R 10/A		R 10/A		R 10/A		R 10/A		R 10/A		-		-	
LOAD GROUP	5		5		5		5		5		-		-	
CALIBRATED	no		no		no		no		no		no		yes	
COLOUR	PG	ARTICLE	PG	ARTICLE	PG	ARTICLE	PG	ARTICLE	PG	ARTICLE	PG	ARTICLE	PG	ARTICLE
1317 CORDA	10	95015-008	66	95015-043	675	95015-022	95	95015-063	105	95015-071	55	95015-103	80	95015-149
1386 NERO		95015-015		95015-044		95015-023		95015-064		95015-072		95015-104		95015-150
1376 GRIGIO	8	95015-013	65	95015-045	675	95015-024	94	95015-065	104	95015-073	54	95015-105	78	95015-151
1372 MARMOS		95015-011		95015-046		95015-025		95015-066		95015-074		95015-106		95015-152
1328 ROSSO	8	95015-014	65	95015-047	675	95015-026	94	95015-067	104	95015-075	54	95015-107	78	95015-153
1313 SANDOS		95015-010		95015-048		95015-027		95015-068		95015-076		95015-108		95015-155
1391 OCTAGON														
1393 BORDER 08														
1394 BORDER 12														
PIECE	kg	1,706		1,727		1,526		3,006		4,372		0,421		0,400
	Piece	11		10		6		4		1		16		2
BUNDLE	m ² /lm	1,00		3,03		1,82		1,21		-		4,85		-
	kg	18,766		17,270		9,156		12,024		4,372		6,736		0,800
	Piece	572		520		192		160		78		2.880		1.704
	m ² /lm	52,00		157,58		58,18		48,48		-		872,73		-
PALLET	kg	976		898		293		481		341		1.212		682
	Bundle	52		52		32		40		78		180		852
M ² /LM	Piece (incl. joint)	11,00		3,30		3,30		3,30		-		3,30		-
	kg	18,766		5,699		5,036		9,920		-		1,389		-
DISCOUNT ON PALLETS		yes		yes		yes		yes		no		no		no
SURCHARGE ¹⁾		yes		yes		yes		no		no		yes		no

PG = Price group (please see price list 2023) ¹⁾ = Minimum quantity: each open box will incur a surcharge. ²⁾ = The marked trim pieces are to be used in accordance with the applicable instructions for use from Ströher GmbH as well as applicable standards and informational leaflets. For further information please see catalogue page 66 or visit our website under www.stroeher.de

³⁾ = The 340 mm tread depth of the loft stair tread corner and tread tile allows flexible use and adjustment, even for non-standard stairs. ⁴⁾ = Not suitable for outdoor use due to natural stone inlays.

The formats shown are illustrative drawings and are not binding. All information without guarantee.

* Ströher grants a 25-year guarantee on frost resistance for the following selected coarse ceramic products and series when laid professionally by a qualified specialist company: Roccia Next, Selected, Gravel Blend, Epos, Aera, Roccia, Terra, Stalotec, Farbklang, Nuancist, Brickwerk, Wasserbrand, Kontur, Riegel 50, Steinlinge, Glanzstücke, Zeitlos und Keravette.



TERRA

Vibrant colours. Original and resilient.

Classic, unique tunnel kiln product. Coloured through, sintered through, durable and easy to clean.

The warm earth tones and surface give the floor an unadulterated, natural look. Terra is ceramic in its original, perhaps even primeval form.

No glaze is needed to achieve this intense colouring and the striking variations in tone. This is where the distinctively intense colours come about quite naturally through the special tunnel kiln firing. And the result is coloured right through and also durable.



Outdoor functional ceramics



Frost resistance
25 year guarantee*



Mechanical adhesive qualities for a safe and permanent bonding.



Ideal for renovations of balconies, terraces and outdoor stairs.



For a perfect floor concept. Stairs, steps and edge finishes.













Sustainable building material.



Energy-efficiently manufactured.

TERRA product details

DIN EN 14411
stoneware tile, extruded
test result precision

	 SPLIT TILE		 SPLIT TILE		 STAIR TREAD TILE		 STAIR TREAD TILE		 ANGLE TILE		 ANGLE TILE WITH GROOVES		 ANGLE TILE BULGING EDGE	
NOMINAL SIZE IN CM	12,5 x 25		25 x 25		12,5		25		25		25		25	
PRODUCTION SIZE IN MM	115 x 240 x 10		240 x 240 x 12		115 x 300 x 14		240 x 300 x 14		240 x 115 x 52 x 10		240 x 115 x 52 x 10		240 x 115 x 52 x 10	
SLIP RESISTANCE	R 11/B		R 11/B		R 11/B		R 11/B		R 11/B		R 11/B		R 11/B	
LOAD GROUP	≤ 275 mm ³		≤ 275 mm ³		≤ 275 mm ³		≤ 275 mm ³		≤ 275 mm ³		≤ 275 mm ³		≤ 275 mm ³	
CALIBRATED	no		no		no		no		no		no		no	
COLOUR	PG	ARTICLE	PG	ARTICLE	PG	ARTICLE	PG	ARTICLE	PG	ARTICLE	PG	ARTICLE	PG	ARTICLE
 0116 WHEAT		95103-002		95103-005					63	95003-010	65	95003-014		
 0127 PATRICIAN RED FLASHED		95103-003	27	95103-006					63	95003-011	65	95003-015		
 0125 PATRICIAN RED		95103-004		95103-007	72	95003-019	69	95003-021		95003-012		95003-016	64	95003-018
PIECE	kg	0,583	1,448	1,140	2,318	0,814	0,813	0,860						
	Piece	21	17	8	6	6	6	6						
BUNDLE	m ² /lm	0,64	1,06	1,00	1,50	1,50	1,50	1,50						
	kg	12,243	24,616	9,120	13,908	4,884	4,878	5,160						
	Piece	1.575	510	480	384	684	684	684						
PALLET	m ² /lm	47,73	31,88	60,00	96,00	171,00	171,00	171,00						
	kg	918	738	547	890	557	556	588						
	Bundle	75	30	60	64	114	114	114						
M ² /LM	Piece (incl. joint)	33,00	16,00	8,00	4,00	4,00	4,00	4,00						
	kg	19,239	23,168	9,120	9,272	3,256	3,252	3,440						
DISCOUNT ON PALLETS		yes	yes	yes	yes	yes	yes	yes						
SURCHARGE ¹⁾		yes	yes	yes	yes	yes	yes	yes						

PG = Price group (please see price list 2023) ¹⁾ = Minimum quantity: each open box will incur a surcharge. ²⁾ = The marked trim pieces are to be used in accordance with the applicable instructions for use from Ströher GmbH as well as applicable standards and informational leaflets. For further information please see catalogue page 66 or visit our website under www.stroeher.de

³⁾ = The 340 mm tread depth of the loft stair tread corner and tread tile allows flexible use and adjustment, even for non-standard stairs. ⁴⁾ = Matching cove base internal corner and cove base external corner to the cove base can be found in the Stalotec range on page 116.

The formats shown are illustrative drawings and are not binding. All information without guarantee.

* Ströher grants a 25-year guarantee on frost resistance for the following selected coarse ceramic products and series when laid professionally by a qualified specialist company: Roccia Next, Selected, Gravel Blend, Epos, Aera, Roccia, Terra, Stalotec, Farbklang, Nuancist, Brickwerk, Wasserbrand, Kontur, Riegel 50, Steinlinge, Glanzstücke, Zeitlos und Keravette.

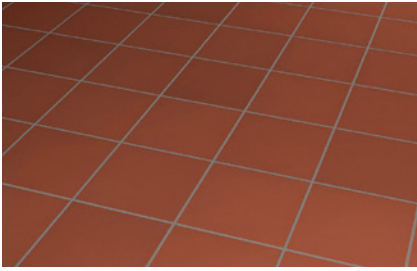

0125 patrician red

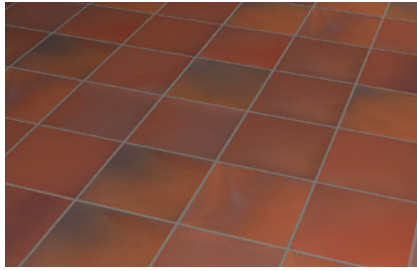

0127 patrician red flashed



0116 wheat



STAIR TREAD TILE



STAIR TREAD CORNER



RISER CORNER



STAIR SKIRTING LEFT



STAIR SKIRTING RIGHT



SKIRTING



COVE BASE ⁴⁾

25	30	-	-	-	25	25	
240 x 340 x 12	345 x 345 x 12	157 x 60 x 60 x 11	294 x 73 x 10	294 x 73 x 10	240 x 73 x 10	240 x 96 x 12	
R 11/B	R 11/B	-	-	-	-	-	
≤ 275 mm ³	≤ 275 mm ³	-	-	-	-	-	
no	no	no	no	no	no	no	
PG	ARTICLE	PG	ARTICLE	PG	ARTICLE	PG	ARTICLE
91	95003-024	102	95003-027	78	95003-042	121	95003-033
	95003-025		95003-028		95003-043		95003-034
	95003-026		95003-029		95003-044		95003-035
2,594	4,372	0,400	0,893	0,893	0,436	0,752	
4	1	2	6	6	12	8	
1,00	-	-	-	-	3,00	2,00	
10,376	4,372	0,800	5,358	5,358	5,232	6,016	
160	78	1.704	648	648	2.208	912	
40,00	-	-	-	-	552,00	228,00	
415	341	682	579	579	963	686	
40	78	852	108	108	184	114	
4,00	-	-	-	-	4,00	4,00	
10,376	-	-	-	-	1,744	3,008	
yes	no	no	no	no	no	no	
no	no	no	no	no	yes	yes	



Completely frost resistant
25 year guarantee*



Tunnel kiln fired



Variety of trim pieces



Fade-free and colourfast



Easy maintenance and hygienic



Abrasion resistant



Anti-slip



In compliance with DIN EN



Ecofriendly



Resistant to chemicals



Glow-resistant and fireproof



Anti-static



euramic
RETRO

**Nostalgia and zeitgeist combined.
Harmonious for your well-being.**

Traditional values. Contemporary staging.

Cosmopolitan in style, yet nostalgic. Perfectly authentic in appearance. Poles strive for harmony. The more fast-paced and high-tech life is perceived, the greater the desire for the well-tried and trusted. Throwing an anchor to halt and catch your breath. That is what Retro conveys on the ground. Retro combines the urge for authenticity and the pursuit of simplicity in a floor ceramic that is easy to clean, resilient and frost-resistant.

RETRO

Extruded. Vintage. Trusted.



Colours



3775 grey



3773 greige



3783 anthracite



Frost resistant



Variety of trim pieces



Fade-free and colourfast



Easy maintenance and hygienic



PEI 5 Abrasion resistant



R 10/A Anti-slip



In compliance with DIN EN



Ecofriendly



Resistant to chemicals



Glow-resistant and fireproof



Anti-static



Outdoor functional ceramics



Frost resistance 25 year guarantee*



Mechanical adhesive qualities for a safe and permanent bonding.



Ideal for renovations of balconies, terraces and outdoor stairs.



For a perfect floor concept. Stairs, steps and edge finishes.



Sustainable building material.



Energy-efficiently manufactured.

RETRO product details

DIN EN 14411
stoneware tile, extruded
test result precision



EXTRUDED STONEWARE TILE

NOMINAL SIZE IN CM	30 x 30	
PRODUCTION SIZE IN MM	294 x 294 x 8	
SLIP RESISTANCE	R 10/A	
LOAD GROUP	5 ²⁾	
CALIBRATED	no	
COLOUR	PG	ARTICLE
● 3775 GREY		95042-002
● 3773 GREIGE	202	95042-003
● 3783 ANTHRACITE ²⁾		95042-004
PIECE	kg	1,510
	Piece	11
BUNDLE	m ² /lm	1,00
	kg	16,610
	Piece	704
PALLET	m ² /lm	64,00
	kg	1.063
	Bundle	64
M ² /LM	Piece (incl. joint)	11,00
	kg	16,610
DISCOUNT ON PALLETS	yes	
SURCHARGE ¹⁾	yes	

PG = Price group (please see price list 2023) ¹⁾ = Minimum quantity: each open box will incur a surcharge. ²⁾ = Colour 3783 anthracite meets loadgroup 4.

The formats shown are illustrative drawings and are not binding. All information without guarantee.



30 x 30 cm CAVAR passione with angle tile and skirting



euramic
CAVAR

**Mediterranean airiness.
Unpretentious but strong in character.**

**Holiday atmosphere – 365 days a year.
Application reliability for the balcony or terrace.**

Vivacious in color and yet soothing in its appearance. A special glaze print creates a depth effect on the body, giving the otherwise rather Mediterranean pastel surface also a touch of southern wildness.

The special angle tile and the extruded body ensure that “Cavar” is perfectly suitable for outdoor use. Sophisticated in its Mediterranean appeal - but reliable in its application.

CAVAR

Extruded. Mediterranean. Expressive.



Colours



1618 facello



1625 passione



1685 fosco



1673 chiaro



Frost resistant



Variety of trim pieces



Fade-free and colourfast



Easy maintenance and hygienic



PEI 5 Abrasion resistant



R 10/A Anti-slip



In compliance with DIN EN



Ecofriendly



Resistant to chemicals



Glow-resistant and fireproof



Anti-static



Outdoor functional ceramics



Frost resistance 25 year guarantee*



Mechanical adhesive qualities for a safe and permanent bonding.



Ideal for renovations of balconies, terraces and outdoor stairs.



For a perfect floor concept. Stairs, steps and edge finishes.



Sustainable building material.



Energy-efficiently manufactured.

CAVAR product details

DIN EN 14411
stoneware tile, extruded
test result precision



EXTRUDED STONWARE TILE



ANGLE TILE ²⁾



STAIR TREAD TILE ^{2) 3)}



SKIRTING

NOMINAL SIZE IN CM		30 x 30	30	30	30			
PRODUCTION SIZE IN MM		294 x 294 x 8	294 x 115 x 52 x 8	294 x 340 x 12	294 x 70 x 8			
SLIP RESISTANCE		R 10/A	R 10/A	R 10/A	-			
LOAD GROUP		5 ³⁾	5 ³⁾	5 ³⁾	-			
CALIBRATED		no	no	no	no			
COLOUR	PG	ARTICLE	PG	ARTICLE	PG	ARTICLE	PG	ARTICLE
1673 CHIARO	1685	95018-002	9966	95018-010	9966	95018-025	9966	95018-014
1618 FACELLO		95018-003		95018-011		95018-026		95018-015
1625 PASSIONE		95018-004		95018-012		95018-027		95018-016
1685 FOSCO ³⁾		95018-005		95018-013		95018-028		95018-017
PIECE	kg	1,510	0,851	3,044	0,377			
	Piece	11	6	4	18			
BUNDLE	m ² /lm	1,00	1,82	1,21	5,45			
	kg	16,610	5,106	12,176	6,786			
	Piece	704	576	160	3.240			
PALLET	m ² /lm	64,00	174,55	48,48	981,82			
	kg	1.063	490	487	1.221			
	Bundle	64	96	40	180			
M ² /LM	Piece (incl. joint)	11,00	3,30	3,30	3,30			
	kg	16,610	2,808	10,045	1,244			
DISCOUNT ON PALLETS		yes	yes	yes	no			
SURCHARGE ¹⁾		yes	yes	no	yes			

PG = Price group (please see price list 2023) ¹⁾ = Minimum quantity: each open box will incur a surcharge. ²⁾ = The marked trim pieces are to be used in accordance with the applicable instructions for use from Ströher GmbH as well as applicable standards and informational leaflets. For further information please see catalogue page 66 or visit our website under www.stroehher.de ³⁾ = Colour 1685 fosco meets loadgroup 4.

The formats shown are illustrative drawings and are not binding. All information without guarantee.

This is how it's done right!

APPLICATION INFORMATION FOR OUTSIDE FLOORING AND OUTSIDE STAIRS

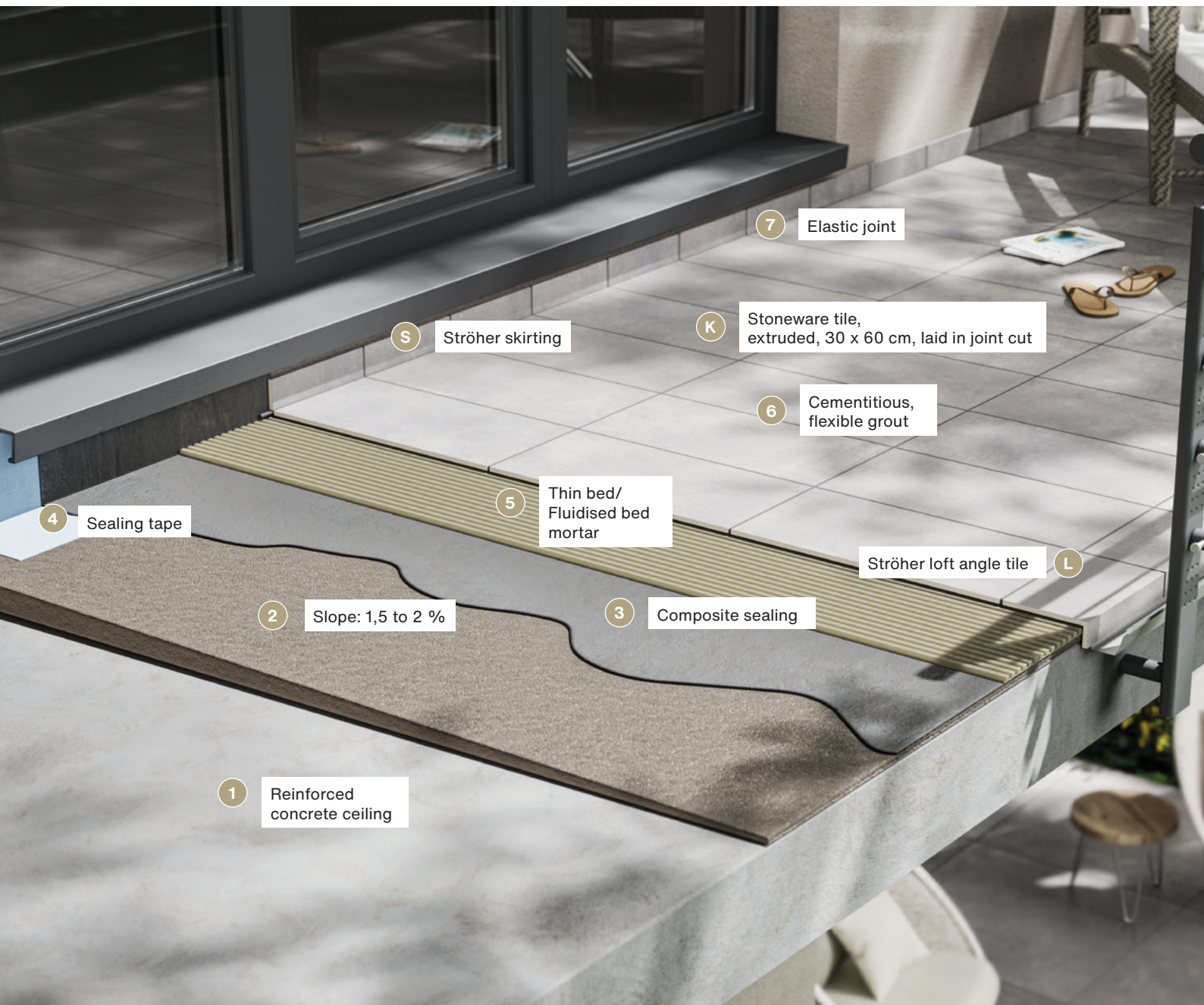

Ceramic coverings in outdoor areas must be executed professionally in accordance with the following codes of practice and standards:

- ZDB bulletin “Exterior coverings: Covering constructions with tiles and slabs outside buildings“, August 2019 edition
- DIN 18531 Waterproofing of roofs as well as balconies, loggias and arcades
- DIN 18195 Waterproofing of structures

The recommendation listed here is exemplary and serves only as a simplified, schematic visualisation. Complaints resulting from improper installation cannot be settled by the manufacturer.



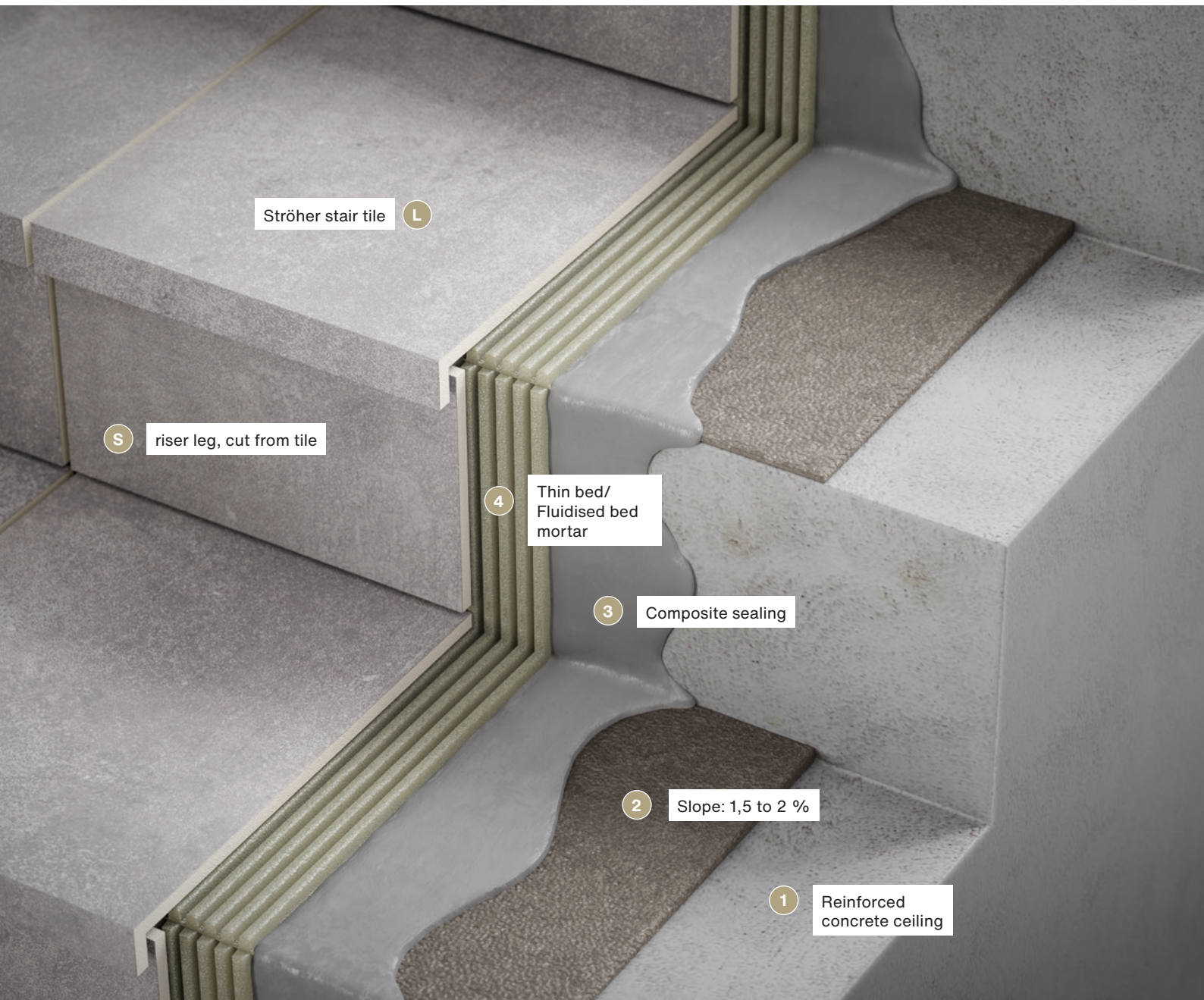

Stairs outdoors and flooring edge finishes with angles, florentines or loft stair tread tiles are further to be used as follows:



To ensure safe stair construction, the riser leg lead is to be positioned behind the stair tread or angle with a gap of 3–4 mm and they are not to be grouted together. Outdoors, the application and grouting of both the stair tread in connection to the riser leg leads to damage for constructional reasons.



STRÖHER
LIVING

GARDEN AND TERRACE SLABS

ABSOLUTE 20 **76**
ORIGIN WOOD 20 **80**
PROCESSING
INSTRUCTIONS **84**

Garden and Terrace slabs: **FREE SPACE IN LARGE SIZE** for your **FAVOURITE OUTDOOR SPOT**

When the sun kisses us and it finally gets warmer in spring, we are drawn out again. Out into your own garden and onto the terrace. Out into the living room for the summer.

The terrace is our very own private retreat, our island of relaxation, to switch off from everyday life and spend time in the green with family and friends. It is our favourite place for the summer months.

Garden and terrace slabs from Ströher Living offer a wide range of options for designing your favourite outdoor space. Completely individual. With your personal touch. And to your liking. For more space and enjoyment, so that outdoors also becomes your favourite place.



For loose or fixed tiling:
**2 CM PORCELAIN
STONEWARE**
Garden and terrace slabs





Ströher Garden Slabs are made of a durable and extra-strong 20 mm porcelain stoneware and are ideal for renovations or new construction of surfaces on patios, balconies, roof top terraces, walkways and driveways.

Wherever the hurdles of load-bearing limits, by structural design and existing structures challenge the surfacing. The garden slabs can be installed fixed, stilted, or loosely in the gravel or crushed stone bed.

Ströher Garden Slabs are fired at 1,200 °C and possess a hard seal on the ceramic shard. Breeding grounds for moss, algae and vermin are thus ultimately eliminated. Even when facing grease, red wine, damp or other stains, Ströher Garden Slabs resist to soiling. Moreover, they are environmentally friendly, as there is no need to use cleaning chemicals. Just warm water is all it takes.



Watch the product
video on YouTube.

STRÖHER
LIVING

Absolute 20 NEW

**The New Feeling Home.
Holistic urban open space.**

Cement. Not minimalist clean. But naturally alive.

Absolute by Ströher Living is the fusion of materiality, zeitgeist and history into a new contemporary design. Not minimalist clean, but homely warm. Naturally lively yet balanced in character. Authentic and multi-faceted in the details with delicate used-look effects. This makes Absolute a new urban look and combines comfort and individuality to create a new, homely cosiness. For a real feeling of being at home.

In the colour shades beige, grey and anthracite, the extra-strong design format 100 x 100 x 2 cm opens up a wide range of design freedom for spacious outdoor areas. The R 10/B surface is easy to clean, slip-resistant and thus also ideally suited for barefoot wet areas.

Absolute 20 NEW



**Cement. Not minimalist clean.
But naturally alive.**

Colours

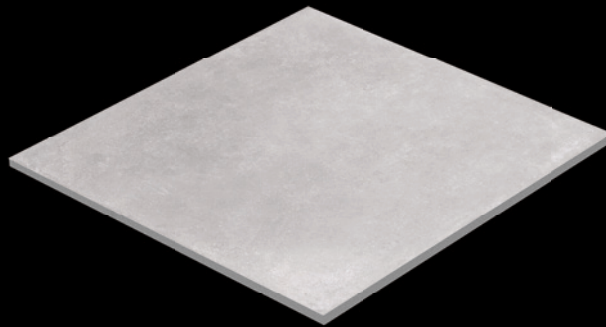

5274 grey matt



5213 beige matt

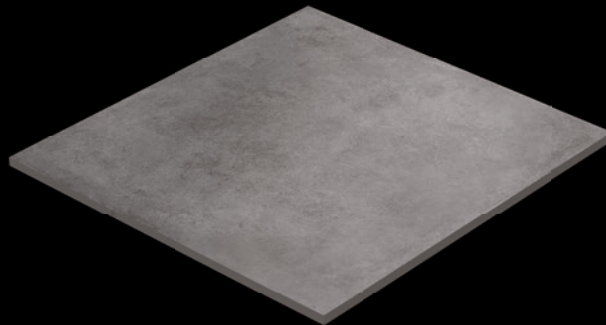

5284 anthracite matt



Frost resistant



Fade-free and colourfast



Easy maintenance and hygienic



Stain and De-icing salt resistant



slip resistance. R 10/B



Highly resilient



Rectified. For a perfect joint pattern



Diverse installation options



Sustainable building material

ABSOLUTE 20 product details

DIN EN 14411
porcelain stoneware tiles,
rectified

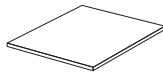

GARDEN SLAB

NOMINAL SIZE IN CM		100 x 100
PRODUCTION SIZE IN MM		998 x 998 x 20
SLIP RESISTANCE		R 10/B
LOAD GROUP		≤ 175 mm ³
RECTIFIED		yes
COLOUR		ARTICLE
●	5274 GREY MATT	95020-002
●	5213 BEIGE MATT	95020-003
●	5284 ANTHRACITE MATT	95020-004
PIECE	kg	39,950
	Piece	1
BUNDLE	m ² /lm	1,00
	kg	39,950
PALLET	Piece	24
	m ² /lm	24,00
	kg	959
	Bundle	24
M ² /LM	Piece (incl. joint)	1,00
	kg	39,950
DISCOUNT ON PALLETS		yes



Normally available ex stock. Price upon request.
The formats shown are illustrative drawings and are not binding.
All information without guarantee.



Watch the product video on YouTube.

STRÖHER
LIVING

Origin Wood 20 NEW

Nature Looks. In its most original form and abundant beauty.

For a natural and comfortable feeling of open space.

Inspired by the natural look of classic precious woods, Origin Wood is modeled after the natural wood in every detail. The multifaceted grains, striking inclusions and subtly matched warm color nuances characterize the filigree surface design. Amazingly and naturally genuine. Not only visually, but also in touch and comfort.

Stylish and slip-resistant, Origin Wood 20 is a 20 mm thick porcelain stoneware garden slab in 40 x 120 cm format with an R 10/B surface.



Watch the product
video on YouTube.

Origin Wood 20 NEW



Nature Looks. In its most original form and abundant beauty.

Colours



4814 walnut



4844 oak



Frost resistant



Fade-free and colourfast



Easy maintenance and hygienic



Stain and De-icing salt resistant



slip resistance. R 10/B



Highly resilient



Rectified. For a perfect joint pattern



Diverse installation options



Sustainable building material

ORIGIN WOOD 20 product details

DIN EN 14411
porcelain stoneware tiles,
rectified

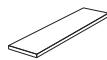

GARDEN SLAB

NOMINAL SIZE IN CM	40 x 120	
PRODUCTION SIZE IN MM	397 x 1197 x 20	
SLIP RESISTANCE	R 10/B	
LOAD GROUP	≤ 175 mm ³	
CALIBRATED	yes	
COLOUR	ARTICLE	
4814 WALNUT	95023-002	
4844 OAK	95023-003	
PIECE	kg	21,505
	Piece	2
BUNDLE	m ² /lm	0,96
	kg	43,010
PALLET	Piece	48
	m ² /lm	23,04
	kg	1.032
	Bundle	24
M ² /LM	Piece (incl. joint)	2,08
	kg	44,795
DISCOUNT ON PALLETS	yes	



Watch the product video on YouTube.

Normally available ex stock. Price upon request.
The formats shown are illustrative drawings and are not binding.
All information without guarantee.

INSTALLATION RECOMMENDATION FOR GARDEN SLABS

Ceramic surfaces in outdoor areas are to be installed in a professional manner in accordance with the following codes of practice and standards:

- ZDB Leaflet „Exterior surfacing: Surfacing constructions with tiles and slabs outside buildings“, August 2019 edition
- DIN 18531 Waterproofing of roofs as well as balconies, loggias and arcades
- DIN 18195 Waterproofing of structures

The specified recommendations are exemplary for the purpose of simplified, schematic visualization only. Complaints resulting from improper installation cannot be regulated by the manufacturer.

Example structure on stilts

Balcony

- ① Concrete support slab
- ② Sloping concrete screed, 1.5 to 2 % slope
- ③ Waterproofing
- ④ Separation layer/building protection mat
- ⑤ Stilt bearing
- ⑥ Garden slabs

Flat roof

- ① Concrete support slab
- ② Sloping concrete screed, min. 2 % slope
- ③ Vapor barrier
- ④ Insulating layer
- ⑤ Waterproofing
- ⑥ Separation layer/building protection mat
- ⑦ Stilt bearing
- ⑧ Garden slabs

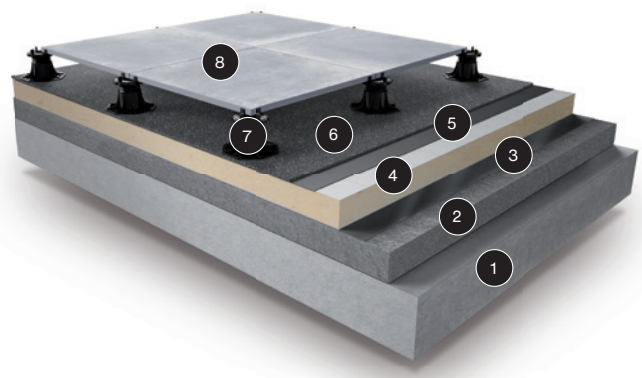
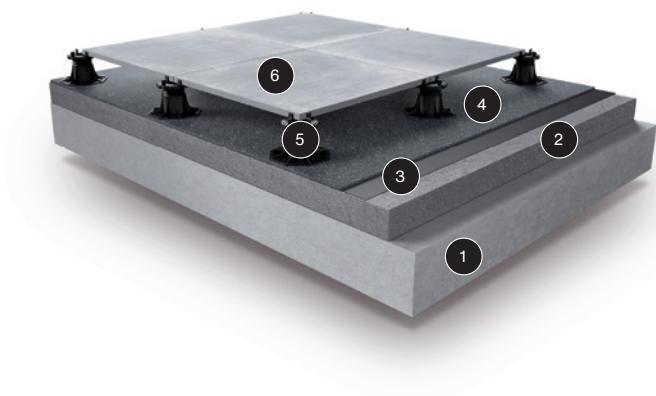

Example installation in grit bed

Terrace, soil-based

- ① Soil ground
- ② Crushed stone bed (grain size 0/32 mm), vibrated
- ③ Water permeable separation layer (Geotextile)
- ④ Grit bed (grain size 2–5 mm)
- ⑤ Grout crosses or gravel and chippings bedding
- ⑥ Garden slabs

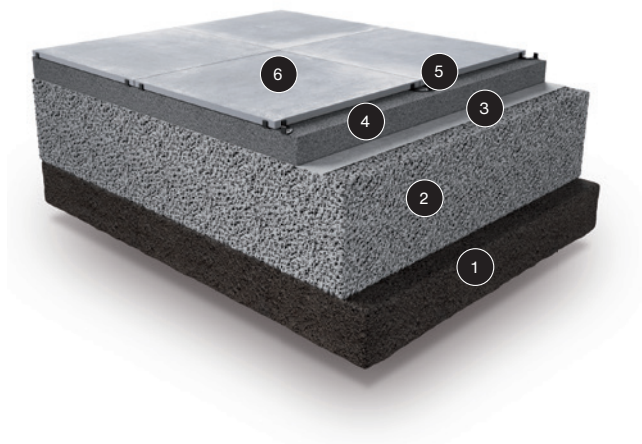

Balcony

- ① Concrete support slab
- ② Sloping concrete screed, 1.5 to 2 % slope
- ③ Waterproofing
- ④ Building protection mat
- ⑤ Grit bed (grain size 2–5 mm)
- ⑥ Grout crosses or gravel and grit bedding
- ⑦ Garden slabs

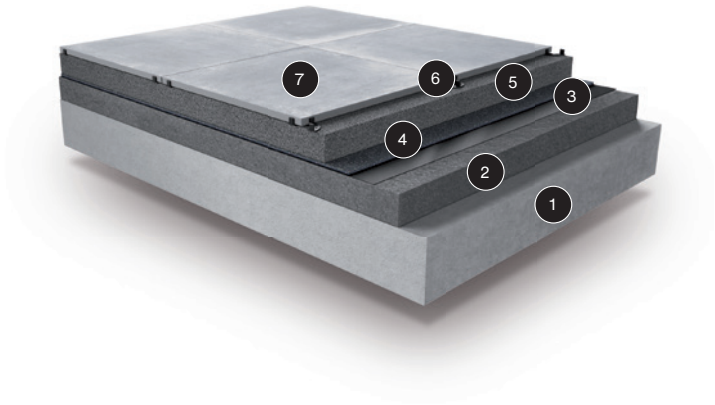

Garden (lawn)

- ① Soil ground
- ② Grit approx. 5 cm in (grain size 2–5 mm)
- ③ Garden slabs

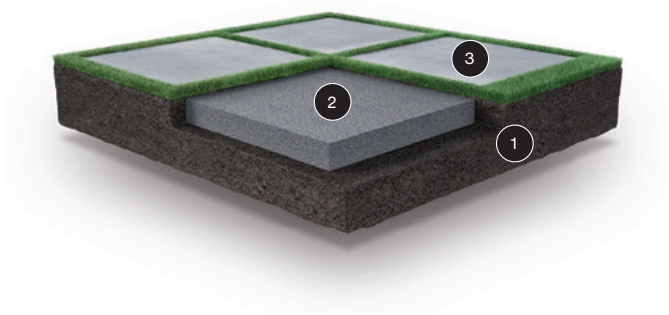

Flat roof

- ① Concrete support slab
- ② Sloping concrete screed, min. 2 % slope
- ③ Vapor barrier
- ④ Insulating layer
- ⑤ Waterproofing
- ⑥ Building protection mat
- ⑦ Grit bed (grain size 2–5 mm)
- ⑧ Grout crosses or gravel and grit bedding
- ⑨ Garden slabs

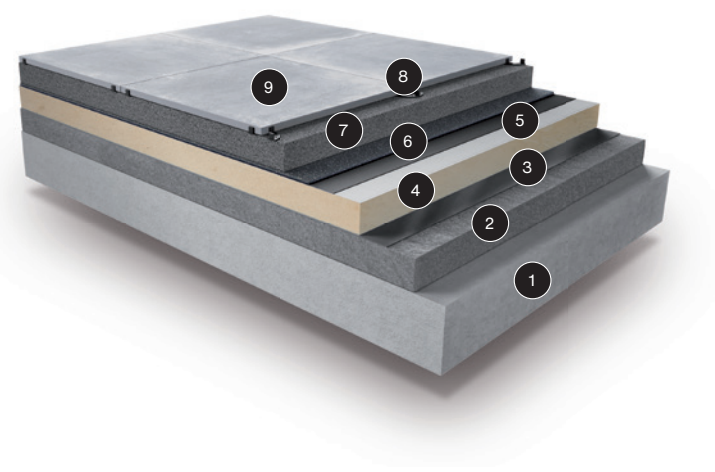

Example for fixed installation

Terrace, on soil ground

- ① Soil ground
- ② Crushed stones bed (grain size 0/32 mm), vibrated, frost-resistant installation
- ③ Water permeable separation layer (Geotextile)
- ④ Drainage / mono-grain mortar
- ⑤ Thin bed/ Fluid bed mortar
- ⑥ Garden slabs installed in buttering floating on hardened drainage / mono-grain mortar.
(Alternatively, not shown in illustration: Installation in fresh mortar bed. Apply adhesive to back of slab and tap into fresh mortar bed).
- ⑦ Flexible cementitious grout

The entire structure (including the surfacing) is to be installed with a slope of 1.5 to 2%.

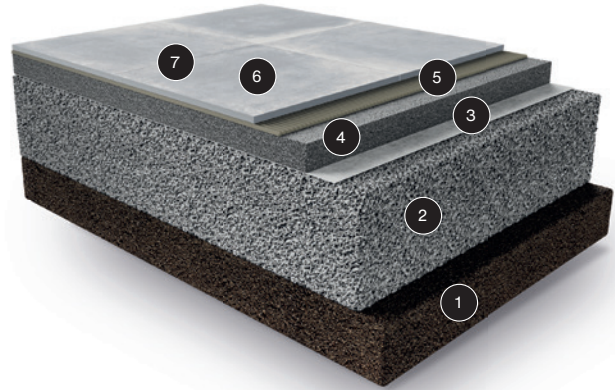

Balcony

- ① Concrete support slab
- ② Sloping concrete screed, 1.5 to 2 % slope
- ③ Waterproofing
- ④ Thin bed/ Fluid bed mortar
- ⑤ Garden slabs installed in buttering floating
- ⑥ Flexible cementitious grout mortar

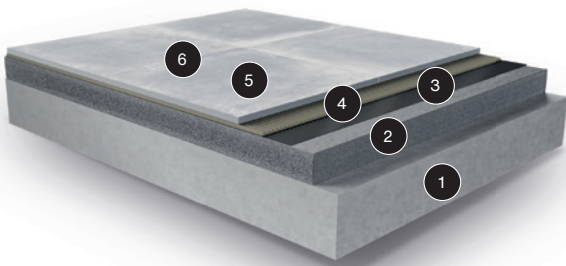

Flat roof

- ① Concrete support slab
- ② Sloping concrete screed, min. 2 % slope
- ③ Vapor barrier
- ④ Insulating layer
- ⑤ Waterproofing
- ⑥ Thin bed/ Fluid bed mortar
- ⑦ Garden slabs installed in buttering floating
- ⑧ Flexible cementitious grout mortar

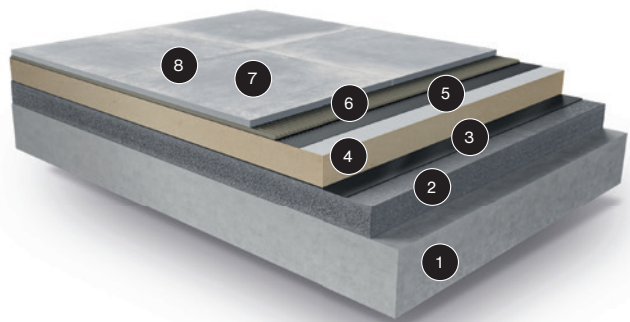







LIVING CERAMICS

- ABSOLUTE **94**
- COLOR BRIX **98**
- ORIGIN WOOD **104**
- BOOST **108**



CONTEMPORARY CERAMIC CULTURE.





Today's design trends paired with tomorrow's ideas and visions. Self-confident and trendy. No show-off. Yet individual and expressive.

Inspired by the most diverse natural habitats and materials, it is with great passion, dedication and attention to detail that we create the so distinctive look of our tile series. In a unique handwriting that is unmistakable. Finely matched to each other, a holistic ceramics flooring and wall concept.

Sustainably manufactured from raw materials obtained in proximity to manufacturing in the most modern and energy-efficient production facilities.

These are tiles from Ströher Living. It is what we understand as a new chapter in contemporary living culture. A natural unity for us and a perfect symbiosis for the diverse, individual interior design styles of our customers of today.



**PERFECT
MATCH:
TILES**
significantly increase
**ENERGY
EFFICIENCY**
with modern
**UNDERFLOOR
HEATING**

HEAT MORE ENERGY-EFFICIENTLY WITH TILES. AND SAVE ON HEATING COSTS.

Most energy is used for heating. Private households need more than two thirds of their final energy consumption to heat rooms. The heating system is therefore the number one energy guzzler. To save costs, it makes sense to start where energy consumption is highest.

Up to 30 percent of the energy costs can be saved by using underfloor heating in combination with ceramic tiling. Compared to other flooring materials such as vinyl, parquet, wood, carpet or laminate, tiles also have clear energy advantages when used with modern underfloor heating systems.

Tiles are particularly good at conducting, storing and efficiently releasing heat into the room. Due to the low thermal resistance, the room can be heated easily and

efficiently without losing much heat. This means that a lower flow temperature and considerably less energy is required.

The indoor climate also benefits. Tiles offer a healthy, allergy-friendly and consistent indoor climate. The warmth of underfloor and wall heating is perceived as particularly pleasant, as it consists of over 70 percent radiant heat that is healthy for the home.

Tiles have enormous energy-saving potential in combination with underfloor heating and are therefore the perfect floor covering for energy-efficient and comfortable heating.





Watch the product
video on YouTube.

STRÖHER
LIVING

Absolute NEW

**The New Feeling Home.
Holistic Urban-Look.**

Cement. Not minimalist clean. But naturally alive.

Absolute by Ströher Living is the fusion of materiality, zeitgeist and history into a new contemporary design. Not minimalist clean, but homely warm. Naturally lively yet balanced in character. Authentic and multi-faceted in the details with delicate used-look effects. This makes Absolute a new urban look and combines comfort and individuality to create a new, homely cosiness. For a real feeling of being at home.

With the four colour shades beige, cotto, grey and anthracite and a diverse range of formats for interiors of 60 x 60 cm, 60 x 120 cm and 120 x 120 cm, Absolute offers individual design options for every living style and living area. The R 10/B surface is easy to clean & slip-resistant and thus also ideally suited for barefoot wet areas.

Absolute NEW



**Cement. Not minimalist clean.
But naturally alive.**

Colours



5274 grey matt



5213 beige matt



5284 anthracite matt



5223 cotto matt



4 Formats



4 Shades



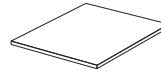

Rectified.
For a perfect
joint patternslip resistance.
R 10/BEnergy-efficient:
Tiles save heating
costs in combination
with underfloor
heatingHealthy living
and allergy
friendlyEasy to
cleanSustainable
building material

ABSOLUTE product details

DIN EN 14411
porcelain stoneware tiles,
rectified

PORCELAIN
STONEWARE TILESPORCELAIN
STONEWARE TILESPORCELAIN
STONEWARE TILES

GARDEN SLAB

NOMINAL SIZE IN CM		60 x 60	60 x 120	120 x 120	100 x 100
PRODUCTION SIZE IN MM		597 x 597 x 8,8	597 x 1197 x 8,8	1197 x 1197 x 6	998 x 998 x 20
SLIP RESISTANCE		R 10/B	R 10/B	R 10/B	R 10/B
LOAD GROUP		≤ 175 mm ³	≤ 175 mm ³	≤ 175 mm ³	≤ 175 mm ³
RECTIFIED		yes	yes	yes	yes
COLOUR		ARTICLE	ARTICLE	ARTICLE	ARTICLE
 5274 GREY MATT		95063-002	95063-006	95063-010	95020-002
 5213 BEIGE MATT		95063-003	95063-007	95063-011	95020-003
 5284 ANTHRACITE MATT		95063-004	95063-008	95063-012	95020-004
 5223 COTTO MATT		95063-005	95063-009		
PIECE	kg	8,010	14,150	20,880	39,950
	Piece	3	2	2	1
BUNDLE	m ² /lm	1,08	1,44	2,88	1,00
	kg	24,030	28,300	41,760	39,950
	Piece	120	64	48	24
PALLET	m ² /lm	43,20	46,08	69,16	24,00
	kg	961	906	1.002	959
	Bundle	40	32	24	24
	Piece (incl. joint)	2,78	1,39	0,69	1,00
M ² /LM	kg	22,252	19,654	14,491	39,950
DISCOUNT ON PALLETS		yes	yes	yes	yes

Normally available ex stock. Price on request.
The formats shown are illustrative drawings and are not binding.
All information without guarantee.

STRÖHER
LIVING

Color Brix NEW

Shine Up Your Style.

Bricks with X. That certain something.

Get out of the uniform grey. And bring colour and sparkle into your living space. With 9 high-gloss shades in a trendy retro-brick look, you can create design sensations. Just the way you like it. A lovely monochrome colour. Or a colourful mix of shades. But definitely glossy. For more creativity and an individual lifestyle.

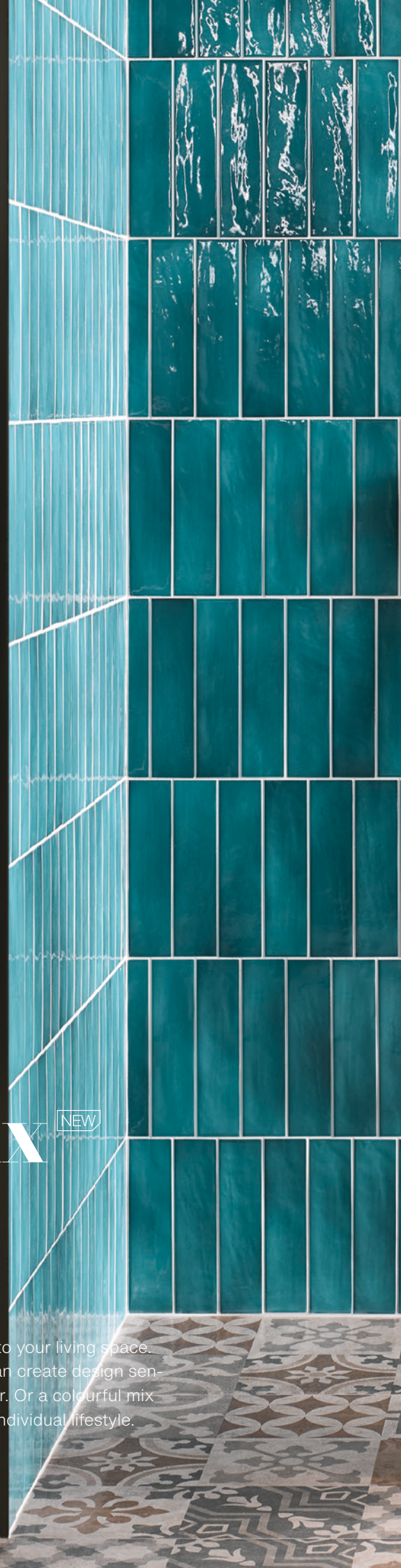







Color Brix ^{NEW}

Bricks with X.
That certain something.



Colours

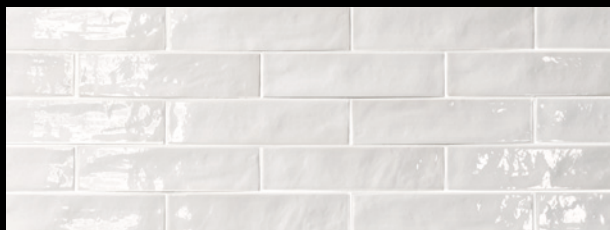

1002 pearl white glossy

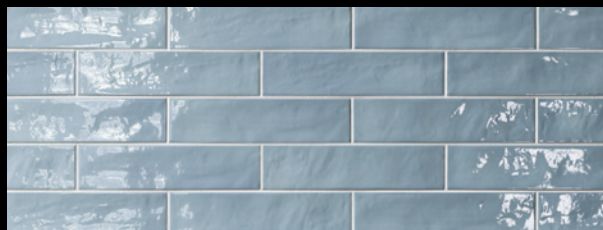

1051 ice blue glossy

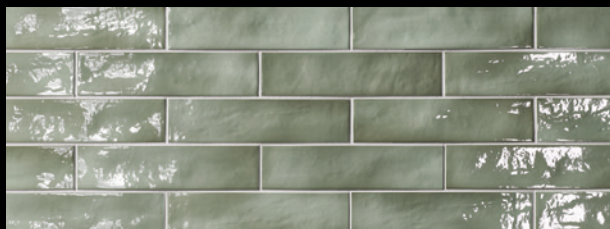

1066 jungle green glossy

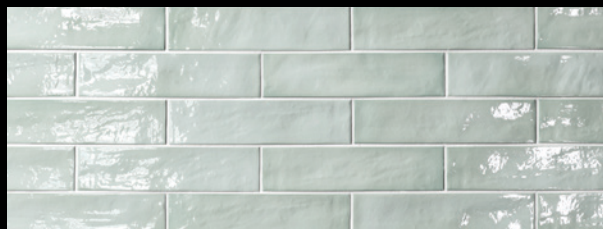

1062 mellow mint glossy



1057 ocean blue glossy



1053 petrol blue glossy

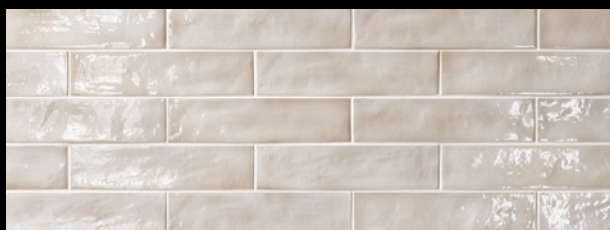

1012 historic beige glossy

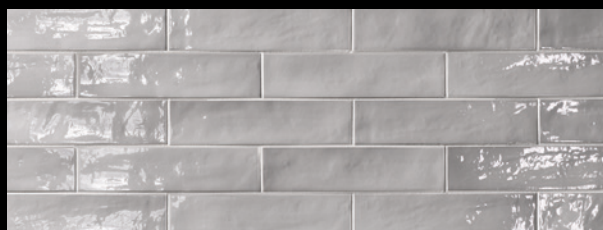

1074 moon grey glossy



1088 space black glossy



1 Brick
Trend format



9 Shades



Energy-efficient:
Tiles save heating
costs in combination
with underfloor
heating



Healthy living
and allergy
friendly



Easy to
clean



Sustainable
building material

COLOR BRIX product details

DIN EN 14411
porcelain stoneware tiles,
rectified



PORCELAIN
STONEWARE SLIPS

NOMINAL SIZE IN CM	25 x 6	
PRODUCTION SIZE IN MM	246 x 60 x 8	
SLIP RESISTANCE	-	
LOAD GROUP	-	
RECTIFIED	no	
COLOUR	ARTICLE	
 1002 PEARL WHITE GLOSSY	95019-002	
 1012 HISTORIC BEIGE GLOSSY	95019-003	
 1062 MELLOW MINT GLOSSY	95019-004	
 1066 JUNGLE GREEN GLOSSY	95019-005	
 1051 ICE BLUE GLOSSY	95019-006	
 1053 PETROL BLUE GLOSSY	95019-007	
 1057 OCEAN BLUE GLOSSY	95019-008	
 1074 MOON GREY GLOSSY	95019-009	
 1088 SPACE BLACK GLOSSY	95019-010	
PIECE	kg	0,276
	Piece	34
BUNDLE	m ² /lm	0,50
	kg	9,384
	Piece	4.080
PALLET	m ² /lm	60,00
	kg	1.126
	Bundle	120
M ² /LM	Piece (incl. joint)	68,00
	kg	18,768
DISCOUNT ON PALLETS	yes	



Normally available ex stock. Price on request.

The formats shown are illustrative drawings and are not binding.
All information without guarantee.



Watch the product
video on YouTube.

STRÖHER
LIVING

Origin Wood UPDATE

Nature Looks. In its most original form and abundant beauty.

Natural and cozy in appearance. For a warm to urban atmosphere.

Inspired by the natural look of classic precious woods, Origin Wood is modeled after the natural wood in every detail. The multifaceted grains, striking inclusions and subtly matched warm color nuances characterize the filigree surface design. Amazingly and naturally genuine. Not only visually, but also in touch and comfort. The choice for the rectified format 23 x 120 cm includes the precious wood tones oak and walnut.

Not only stylish, but also slip-proof, the Origin Wood Series with an R10/B surface also provides the necessary slip protection in wet and barefoot areas such as showers or bathrooms, in representative or public areas, in stores, lobbies or in restaurants.

Origin Wood

Nature Looks.

In its most original form and abundant beauty.



Colours



4814 walnut



4844 oak



2 Formats



2 Shades



Rectified.
For a perfect
joint pattern



slip resistance.
R 10/B



Energy-efficient:
Tiles save heating
costs in combination
with underfloor
heating



Healthy living
and allergy
friendly



Easy to
clean



Sustainable
building material

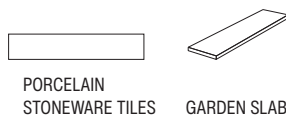

ORIGIN WOOD product details

DIN EN 14411
porcelain stoneware tiles,
rectified



PORCELAIN
STONEWARE TILES

GARDEN SLAB

NOMINAL SIZE IN CM		23 x 120	40 x 120
PRODUCTION SIZE IN MM		227 x 1195 x 9,7	397 x 1197 x 20
SLIP RESISTANCE		R 10/B	R 10/B
LOAD GROUP		≤ 175 mm ³	≤ 175 mm ³
RECTIFIED		yes	yes
COLOUR		ARTICLE	ARTICLE
 4814 WALNUT		95055-003	95023-002
 4844 OAK		95055-004	95023-003
PIECE	kg	5,625	21,505
	Piece	4	2
BUNDLE	m ² /lm	1,09	0,96
	kg	22,500	43,010
PALLET	Piece	216	48
	m ² /lm	58,60	23,04
	kg	1,215	1,032
	Bundle	54	24
M ² /LM	Piece (incl. joint)	3,69	2,08
	kg	20,734	44,795
DISCOUNT ON PALLETS		yes	yes

Normally available ex stock. Price on request.
The formats shown are illustrative drawings and are not binding.
All information without guarantee.





STRÖHER
LIVING

Boost

**Metropolitan concrete Design.
Glam gloss matte effect with a strong structure.**

Urban chic: interpreting style with lightness and elegance.

Whether in cool gray, bold anthracite or warm sandy beige, the unmistakable concrete character of our Boost Series creates a very special atmosphere with its oscillating surface effects in a spatula finish and the refined glam-gloss matte effect surface. Boost stands for a gentle urban living feeling with discreet elegance, rather than the typical industrial style. Just for that certain something that creates an individual and unique look.

The high-quality finish of the Boost Series is compelling: available in the 30 x 60 cm and 60 x 60 cm formats, the tiles are distinguished by their high dimensional stability and, featuring rectified edges, can be grouted with the smallest possible grout joints. The surface is easy to maintain and has an R10 slip resistance surface.

Boost

Metropolitan concrete Design.
Glam gloss matte effect with a strong structure.

Colours



3475 grey matt



3412 greige matt

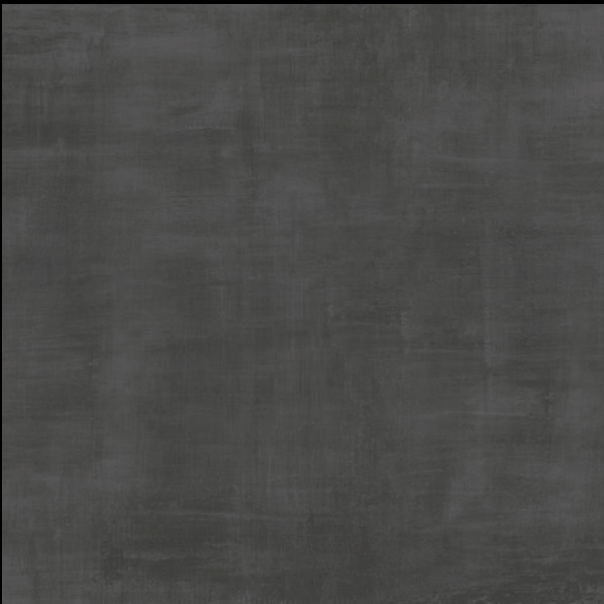

3483 anthracite matt



2 Formats
+ Skirting



3 Shades



Rectified.
For a perfect
joint pattern



slip resistance.
R 10



Energy-efficient:
Tiles save heating
costs in combination
with underfloor
heating



Healthy living
and allergy
friendly



Easy to
clean



Sustainable
building material

BOOST product details

DIN EN 14411
porcelain stoneware tiles,
rectified

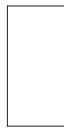

PORCELAIN
STONEWARE TILES



PORCELAIN
STONEWARE TILES



SKIRTING

NOMINAL SIZE IN CM		30 x 60	60 x 60	60
PRODUCTION SIZE IN MM		300 x 600 x 10	600 x 600 x 10	80 x 600 x 10
SLIP RESISTANCE		R 10	R 10	-
LOAD GROUP		≤ 175 mm ³	≤ 175 mm ³	≤ 175 mm ³
RECTIFIED		yes	yes	yes
COLOUR	ARTICLE	ARTICLE	ARTICLE	
● 3475 GREY MATT	95037-002	95037-005	95037-008	
● 3412 GREIGE MATT	95037-003	95037-006	95037-009	
● 3483 ANTHRACITE MATT	95037-004	95037-007	95037-010	
PIECE	kg	4,083	7,762	1,070
	Piece	5	4	14
BUNDLE	m ² /lm	0,90	1,44	8,38
	kg	20,415	31,048	14,980
PALLET	Piece	240	120	560
	m ² /lm	43,20	43,20	335,33
	kg	980	931	599
	Bundle	48	30	40
M ² /LM	Piece (incl. joint)	5,56	2,78	1,67
	kg	22,685	21,563	1,787
DISCOUNT ON PALLETS		yes	yes	no

Normally available ex stock. Price on request.
The formats shown are illustrative drawings and are not binding.
All information without guarantee.



Project
**INDUSTRIAL
FLOORINGS**

STALOTEC 114





STALOTEC

**Extra strong with extra traction
due to overthickness and extrusion.**

**Coloured through. Abrasion resistant. In many thicknesses
Indestructible thanks to continuous firing.**

This ceramic is produced in an extrusion process. The highly textured quality of its reverse side enables it to optimally interlock with the ground and yields a tensile bond strength that even withstands dynamic or rolling loads.

After a special tunnel kiln firing hardly any other floor is as tough and hard-wearing as this extruded industrial floor tiling – for indoors and, thanks to integrated frost resistance due to the special production process, for outdoors as well. Solid-coloured for abrasion resistance and with a material thickness of up to 20 mm Stalotec® split tiles withstand even the heaviest mechanical stresses caused by heavy machinery or forklift trucks. Even chemical stress caused by harsh cleaning materials or acids cannot damage the unglazed surface. The right choice when it comes to heavy load stresses, durability and solid quality.

STALOTEC

Extra strong. Anti-slip. Heavy loads.

STALOTEC product details

DIN EN 14411
stoneware tile, extruded
test result precision



SPLIT TILE



SPLIT TILE



SPLIT TILE



SPLIT TILE

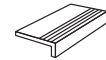

ANGLE TILE

ANGLE TILE
WITH GROOVES

NOMINAL SIZE IN CM		12,5 x 25	12,5 x 25	12,5 x 25	12,5 x 25	25	25
PRODUCTION SIZE IN MM		115 x 240 x 10	115 x 240 x 13	115 x 240 x 15	115 x 240 x 18	240 x 115 x 52 x 10	240 x 115 x 52 x 10
SLIP RESISTANCE		R 11/B	R 11/B	R 11/B	R 11/B	R 11/B	R 11/B
LOAD GROUP		≤ 275 mm ³	≤ 275 mm ³	≤ 275 mm ³	≤ 275 mm ³	≤ 275 mm ³	≤ 275 mm ³
CALIBRATED		no	no	no	no	no	no
COLOUR		PG	ARTICLE	PG	ARTICLE	PG	ARTICLE
● 0914 BEIGE		5	95111-002 ⁴⁾	8	95111-003	9	95111-005
		1	95103-004	15	95111-004	21	95111-006
● 0925 RED						362	95111-008 ⁴⁾
						63	95003-012
PIECE	kg	0,583	0,762	0,897	1,109	0,814	0,813
	Piece	21	16	14	11	6	6
BUNDLE	m ² /lm	0,64	0,48	0,42	0,33	1,50	1,50
	kg	12,243	12,192	12,558	12,199	4,884	4,878
PALLET	Piece	1.575	1.200	1.050	825	684	684
	m ² /lm	47,73	36,36	31,82	25,00	171,00	171,00
	kg	918	914	942	915	557	556
	Bundle	75	75	75	75	114	114
M ² /LM	Piece (incl. joint)	33,00 ³⁾	33,00 ³⁾	33,00 ³⁾	33,00 ³⁾	4,00	4,00
	kg	19,239	25,146	29,601	36,597	3,256	3,252
DISCOUNT ON PALLETS		yes	yes	yes	yes	yes	yes
SURCHARGE ¹⁾		yes	yes	yes	yes	yes	yes

PG = Price group (please see price list 2023) ¹⁾ = Minimum quantity: each open box will incur a surcharge. ²⁾ = The marked trim pieces are to be used in accordance with the applicable instructions for use from Ströher GmbH as well as applicable standards and informational leaflets. For further information please see catalogue pages 66 or visit our website under www.stroehher.de.

³⁾ = For tiling by vibration method the number of pieces required increases to 36,3 pieces per m². The price will be adjusted to the number of pieces required.

⁴⁾ = Made to order - delivery terms upon request.

The formats shown are illustrative drawings and are not binding. All information without guarantee.

* Ströher grants a 25-year guarantee on frost resistance for the following selected coarse ceramic products and series when laid professionally by a qualified specialist company: Roccia Next, Selected, Gravel Blend, Epos, Aera, Roccia, Terra, Stalotec, Farbklang, Nuancist, Brickwerk, Wasserbrand, Kontur, Riegel 50, Steinlinge, Glanzstücke, Zeitlos und Keravette.



0914 beige



0925 red



SKIRTING



COVE BASE



COVE BASE
INTERNAL CORNER



COVE BASE
EXTERNAL CORNER

PG	ARTICLE	PG	ARTICLE	PG	ARTICLE	PG	ARTICLE
25		25		25		25	
240 x 73 x 10		240 x 96 x 12		115 x 96 x 12		115 x 96 x 12	
-		-		-		-	
-		-		-		-	
no		no		no		no	
50	95011-044	60	95011-050	120	95011-058	120	95011-064
	95003-032		95003-039		95003-040		95003-041
0,436		0,752		0,758		0,564	
12		8		6		8	
3,00		2,00		-		-	
5,232		6,016		4,548		4,512	
2.208		912		684		912	
552,00		228,00		-		-	
963		686		518		514	
184		114		114		114	
4,00		4,00		-		-	
1,744		3,008		-		-	
no		no		no		no	
yes		yes		no		no	

Also available in R 12 surfaces! Delivery terms upon request.



Completely frost resistant 25 year guarantee*



Tough and long-lasting



Variety of trim pieces



Fade-free and colourfast



Easy maintenance and hygienic



Abrasion resistant



Anti-slip



In compliance with DIN EN



Ecofriendly



Resistant to chemicals



Glow-resistant and fireproof



Anti-static



Facade

CLINKER BRICK SLIPS

NUANCIST **126**
FARBKLANG **132**
WASSERBRAND **138**
KONTUR **144**
BRICKWERK **150**
RIEGEL 50 **154**
STEINLINGE **158**
GLANZSTÜCKE **162**
ZEITLOS **166**
KERAVETTE **172**
PROCESSING
INSTRUCTIONS **176**





Not just a
FACADE,
but a true
STATEMENT.

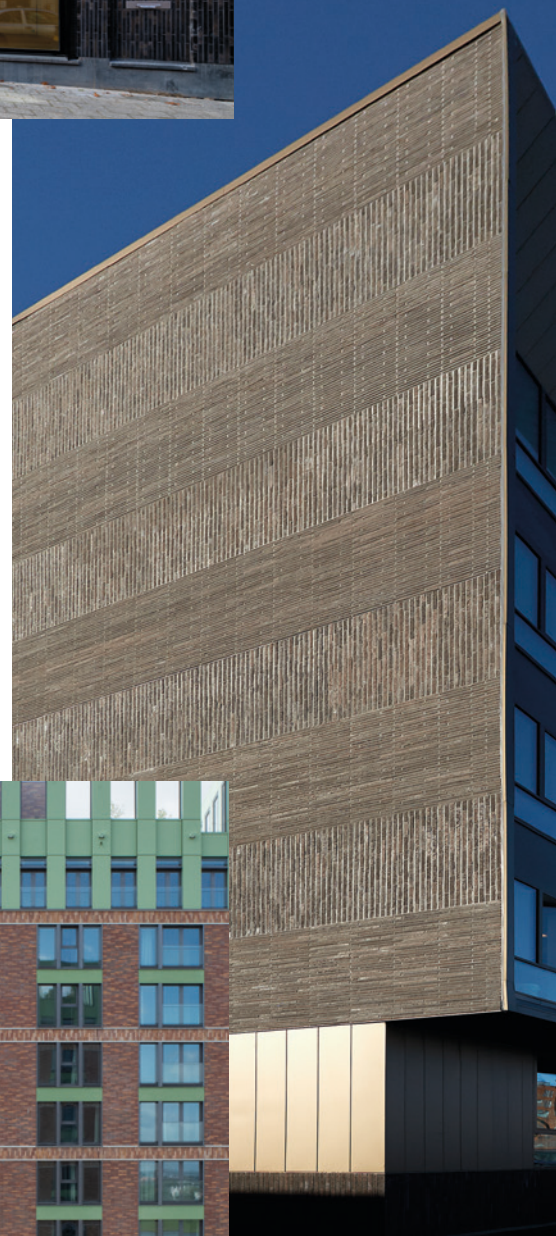



Emphasizing with clinker brick slips.

Clinker brick slips facades do not crumble. Even when scratched. Understatement to statement, we understand clinker brick slips.

Energy-efficient - and sustainably sinter fired. Reduced, oxidized or engobed. Monochrome or in an distinctive, oscillating play of colors. With a wide range of surfaces. From gentle water strokes to expressive charcoal firing. In classic standard size or thin format (NF/DF). Also in the sophisticated long format or bar format.

On the exterior wall of a house, in full cladding or accentuating. For a sustainable statement.

CLINKER BRICK SLIPS

remain
dazzling.



Clinker brick slips are a combination of the archaic and the high-tech. In their application, they integrate aspects such as sustainability, conservation and preservation of value, while supporting an individual and intelligent facade design. Matching the cityscape. Or matching your own or preferred character. Steady in the midst of the constant changes in contemporary architectural trends.

Clinker bricks are a classic building material. And clinker brick slips put exposed masonry right back in the limelight. In combination with external thermal insulation composite systems, clinker brick slips deliver top performance in terms of sustainability and impact.

This building material is our tradition. One we have been reinterpreting in a refreshing way repeatedly for more than 139 years.



COURTYARD
BY MARRIOTT

52



Indoors as an
ACCENTUATING
WALL DECORATION.





Providing a new sense of space. And a lasting impression.

Clinker brick slips leave a lasting impression not only on exterior facades. The thin clinker bricks are nowadays used for wall design in a great variety of interiors and provide the desired comfort and atmosphere.

The diversity of colors, formats and surfaces opens up almost limitless creative scope for individual design ideas within one's own four walls. Designing with clinker brick slips not only focuses on individual living areas such as the living room, dining area, bathroom, bedroom, staircases, accent wall panels or column cladding, but also creates a new and holistic sense of space.



Sandy rough in essence.
Nuanced in character.
Progressive in effect.

NUANCIST NEW

EXCLUSIVE
ARCHITECTURE
RANGE:
EXCLUSIVE MARKE-
TING IN THE PRO-
JECT BUSINESS



EXCLUSIVE
ARCHITECTURE
RANGE:
EXCLUSIVE MAR-
KETING IN THE PRO-
JECT BUSINESS



Resource-saving extruded.



Energy-efficiently manufactured.



Sustainable building material.



High-quality facade covering for installation systems.



Durable and economical.



Frost resistance 25 year guarantee*

NUANCIST NEW

Nuancist is a new and uniquely sanded clinker brick slip that works in both detailed and large surface designs. The different surfaces subtly blend into each other in terms of character and intensity, creating a lively but cohesive play of colours. Natural ageing effects and traces of use that show on the surface and on the edge give Nuancist its special charm.

Nuancist is not sawn from whole bricks, but is extruded as a thin clinker brick slip and manufactured energy-efficiently at 1.200 degrees in sinter firing. This saves raw materials, energy and waste and makes these clinker brick slips a particularly sustainable building material.

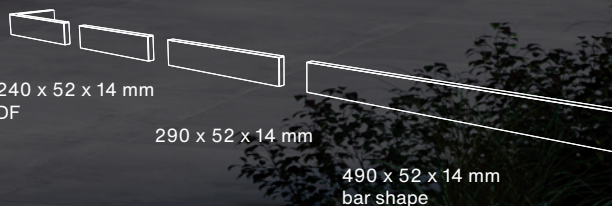

NUANCIST NEW

9 shades in a nuanced variety of colours.

Firings and formats



1810 beige-white

Δ < 6 % · DIN EN 14411, Gr. All_g-Test1



1872 greige

Δ < 6 % · DIN EN 14411, Gr. All_g-Test1

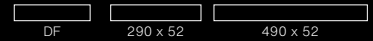

1812 cream-beige

Δ < 6 % · DIN EN 14411, Gr. All_g-Test1



1841 grey-brown

Δ < 6 % · DIN EN 14411, Gr. All_g-Test1



1814 sand-beige

Δ < 6 % · DIN EN 14411, Gr. All_g-Test1



Completely frost resistant
25 year guarantee*



Suitable for
insulation systems



Wheaterproof



Economic



In compliance
with DIN EN



Fade-free and
colourfast



Easy maintenance
and hygienic



Ecofriendly



Resistant to
chemicals



Glow-resistant
and fireproof



Anti-static



1874 grey

△ < 6 % · DIN EN 14411, Gr. All_g-Tst1

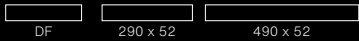

1823 red

△ < 6 % · DIN EN 14411, Gr. All_g-Tst1



1888 black

△ < 6 % · DIN EN 14411, Gr. All_g-Tst1

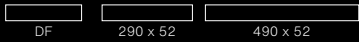

1847 brown

△ < 6 % · DIN EN 14411, Gr. All_g-Tst1



EXCLUSIVE ARCHITECTURE RANGE:
EXCLUSIVE MARKETING IN THE PROJECT BUSINESS



Original in essence.
Colourful in character.
Expressive in its effect.

FARBKLANG NEW

EXCLUSIVE
ARCHITECTURE
RANGE:
EXCLUSIVE MARKE-
TING IN THE PRO-
JECT BUSINESS



EXCLUSIVE
ARCHITECTURE
RANGE:
EXCLUSIVE MAR-
KETING IN THE PRO-
JECT BUSINESS



Resource-saving
extruded.



Energy-efficiently
manufactured.



Sustainable
building
material.



High-quality
facade covering for
installation systems.



Durable and
economical.



Frost resistance
25 year guarantee*

FARBKLING NEW

This is how intensively clinker brick works: Farbklang is a classic reduction clinker brick with rich, luminous shades and a fiery play of colour. The independent surface with its diverse details and effects is, in typical clinker brick style, imperfectly perfect and original. The natural ageing effects and traces of use that appear on the surface and on the edge give colour tone its intense and expressive character.

Farbklang is not sawn from whole bricks, but is extruded as a thin clinker brick slip and manufactured energy-efficiently at 1.200 degrees in sinter firing. This saves raw materials, energy and waste and makes these clinker brick slip a particularly sustainable building material.



240 x 71 x 14 mm
NF

FARBKLANG NEW

10 shades in an intensive variety of colours.

Firings and formats



2127 red flashed

Δ < 6 % · DIN EN 14411, Gr. All_g-Test1



2158 blue brown

Δ < 6 % · DIN EN 14411, Gr. All_g-Test1



2129 purple flashed

Δ < 6 % · DIN EN 14411, Gr. All_g-Test1



2178 grey flashed

Δ < 6 % · DIN EN 14411, Gr. All_g-Test1



2144 brown flashed

Δ < 6 % · DIN EN 14411, Gr. All_g-Test1



2185 anthracite flashed

Δ < 6 % · DIN EN 14411, Gr. All_g-Test1



Completely frost resistant
25 year guarantee*



Suitable for
insulation systems



Weatherproof



Economic



In compliance
with DIN EN



Fade-free and
colourfast



Easy maintenance
and hygienic



Ecofriendly



Resistant to
chemicals



Glow-resistant
and fireproof



Anti-static



2113 light beige

Δ < 6 % · DIN EN 14411, Gr. All_g-Tst1



NF



2173 light grey

Δ < 6 % · DIN EN 14411, Gr. All_g-Tst1



NF



2125 red

Δ < 6 % · DIN EN 14411, Gr. All_g-Tst1



NF



2182 anthracite

Δ < 6 % · DIN EN 14411, Gr. All_g-Tst1



NF

EXCLUSIVE ARCHITECTURE RANGE: EXCLUSIVE MARKETING IN THE PROJECT BUSINESS





WASSERBRAND

Gently rough water-struck look with modern accents.

CO-
LOUR- &
FORMAT-
UPDATE

Confident historical water-struck contouring on the full body.

The light nuanced shades appear lovely but still sharp. The gently rough surfaces and detailed structures are furrowed by water and powerful. It is the skilful blend of untamed and yet delicate accents that gives this simple yet expressive clinker brick slip its striking contemporary look. Because, here, the look of historical water-struck bricks is not manufactured in traditional solid brick, but extruded as a modern clinker brick slip with innovative surface technologies.



240 x 52 x 12 mm
DF



240 x 71 x 12 mm
NF



490 x 40 x 12 mm
Bar shape

WASSERBRAND UPDATE

Powerful. Tender. Untamed.

Firings and formats



4409 sandweiß
 $\Delta < 3\%$ · DIN EN 14411, Gr. AII₂



4472 zinngrau
 $\Delta < 3\%$ · DIN EN 14411, Gr. AII₂



4413 kornbeige
 $\Delta < 3\%$ · DIN EN 14411, Gr. AII₂



4475 graumelange
 $\Delta < 3\%$ · DIN EN 14411, Gr. AII₂



4415 naturbeige
 $\Delta < 3\%$ · DIN EN 14411, Gr. AII₂



4477 rauchgrau
 $\Delta < 3\%$ · DIN EN 14411, Gr. AII₂



4425 lavarot
 $\Delta < 6\%$ · DIN EN 14411, Gr. AIII₂-Tat1



4427 oxidrot
 $\Delta < 6\%$ · DIN EN 14411, Gr. AIII₂-Tat1



Completely frost resistant
25 year guarantee*



Suitable for
insulation systems



Wheaterproof



Economic



In compliance
with DIN EN



Fade-free and
colourfast



Easy maintenance
and hygienic



Ecofriendly



Resistant to
chemicals



Glow-resistant
and fireproof



Anti-static



WASSERBRAND

Powerful. Tender. Untamed.

WASSERBRAND product details

DIN EN 14411
 Clinker brick slips, extruded
 test result precision
 test result nature



CLINKER
BRICK SLIP



CORNER



LINTEL ANGLE



CLINKER
BRICK SLIP



CORNER



LINTEL ANGLE

NOMINAL SIZE IN CM		DF	DF	DF	NF	NF	NF							
PRODUCTION SIZE IN MM		240 x 52 x 12		240 x 115 x 52 x 12		240 x 115 x 52 x 12		240 x 71 x 12		240 x 115 x 71 x 12		240 x 115 x 71 x 12		
COLOUR	PG	ARTICLE	PG	ARTICLE	PG	ARTICLE	PG	ARTICLE	PG	ARTICLE	PG	ARTICLE		
		4409 SANDWEISS		95051-002		95051-020		95051-036		95051-010		95051-028		95051-044
	31	95051-003	765	95051-021	88	95051-037	31	95051-011	768	95051-029	85	95051-045		
		95051-005		95051-023		95051-039		95051-013		95051-031		95051-047		
		95051-004		95051-022		95051-038		95051-012		95051-030		95051-046		
	342	95051-008	766	95051-026	90	95051-042	342	95051-016	771	95051-034	87	95051-050		
		95051-009		95051-027		95051-043		95051-017		95051-035		95051-051		
	392	95051-006	769	95051-024	795	95051-040	392	95051-014	769	95051-032	822	95051-048		
		95051-007		95051-025		95051-041		95051-015		95051-033		95051-049		
PIECE	kg	0,312 / 0,330 ²⁾		0,462 / 0,490 ²⁾		0,898 / 0,951 ²⁾		0,427 / 0,452 ²⁾		0,618 / 0,655 ²⁾		1,070 / 1,135 ²⁾		
	Piece	52		14		6		39		14		4		
BUNDLE	m ² /lm	0,81		0,87		1,50		0,81		1,12		1,00		
	kg	16,224 / 17,160 ²⁾		6,468 / 6,680 ²⁾		5,388 / 5,706 ²⁾		16,653 / 17,628 ²⁾		8,652 / 9,170 ²⁾		4,280 / 4,540 ²⁾		
	Piece	4,212		910		684		3,159		910		456		
PALLET	m ² /lm	65,81		56,42		171,00		65,81		72,80		114,00		
	kg	1,314 / 1,390 ²⁾		420 / 446 ²⁾		614 / 650 ²⁾		1,349 / 1,428 ²⁾		562 / 596 ²⁾		488 / 518 ²⁾		
	Bundle	81		65		114		81		65		114		
M ² /LM	Piece (incl. joint)	64,00		16,13		4,00		48,00		12,50		4,00		
	kg	19,968 / 21,120 ²⁾		7,452 / 7,904 ²⁾		3,592 / 3,804 ²⁾		20,496 / 21,696 ²⁾		7,725 / 8,188 ²⁾		4,280 / 4,540 ²⁾		
DISCOUNT ON PALLETS		yes		yes		yes		yes		yes		yes		
SURCHARGE ¹⁾		yes		yes		yes		yes		yes		yes		

PG = Price group (please see price list 2023) ¹⁾ = Minimum quantity: each open box will incur a surcharge. ²⁾ = Weight indications for the colours 4425 lavarot and 4427 oxidrot. The squareness of angled aprons is defined in the Ströher factory standard. The permissible tolerance value $\alpha \pm 1,5^\circ$. For more information, see the section „General requirements and tests“ on page 180.

The formats shown are illustrative drawings and are not binding. All information without guarantee.

* Ströher grants a 25-year guarantee on frost resistance for the following selected coarse ceramic products and series when laid professionally by a qualified specialist company: Roccia Next, Selected, Gravel Blend, Epos, Aera, Roccia, Terra, Stalotec, Farbklang, Nuancist, Brickwerk, Wasserbrand, Kontur, Riegel 50, Steinlinge, Glanzstücke, Zeitlos und Keravette.



Resource-saving extruded.



Energy-efficiently manufactured.



Sustainable building material.



High-quality facade covering for installation systems.



Durable and economical.



Frost resistance 25 year guarantee*



CLINKER BRICK SLIP



CORNER



LINTEL ANGLE

CLINKER BRICK SLIP		CORNER		LINTEL ANGLE	
Bar shape		-		-	
490 x 40 x 12		240 x 115 x 40 x 12		240 x 115 x 40 x 12	
PG	ARTICLE	PG	ARTICLE	PG	ARTICLE
468	95051-018	762	95051-071	81	95051-074
	95051-069		95051-072		95051-075
47	95051-019	763	95051-068	82	95051-076
47	95051-070	763	95051-073	82	95051-077
0,480		0,334		0,838	
40		24		6	
1,04		1,25		1,50	
19,200		8,016		5,028	
1.440		1.560		684	
37,59		81,12		171,00	
691		521		573	
36		65		114	
38,31		19,23		4,00	
18,389		6,423		3,352	
yes		yes		yes	
yes		yes		yes	



KONTUR

CO-
LOUR- &
FORMAT-
UPDATE

**Perfectly natural.
Fusion finish. Clinker body.**

Traditional clinker looks interpreted with modern contouring.

Targeted highlighting for maximum effect. Contouring is the name of a style that is currently on trend, which gives a natural surface a particularly rounded and modern feel by means of strategic accentuation using the latest surface technology. Here, traditional clinker production techniques are combined with high-tech glaze technology to create a new generation of clinker brick slips: Manufactured in fusion finish.

In the classic DF/NF or long format, with three surfaces. Textures created using smooth engobes, characteristic water-struck surfaces or fire and melted effects with authentic signs of wear – with Kontur, traditional clinker looks have been interpreted and perfected with modern contouring.



240 x 52 x 12 mm
DF



240 x 71 x 12 mm
NF



440 x 52 x 12 mm
Long format

no Entrance
kein Eingang

KONTUR

Expressive. Next-level brick slips. The best of both worlds.

Firings and formats



3915 beige engobed

Δ < 3 % · DIN EN 14411, Gr. A₁



3912 light beige engobed

Δ < 3 % · DIN EN 14411, Gr. A₁



3913 beige-flashed engobed

Δ < 3 % · DIN EN 14411, Gr. A₁



3974 grey engobed

Δ < 3 % · DIN EN 14411, Gr. A₁



3975 grey-flashed engobed

Δ < 3 % · DIN EN 14411, Gr. A₁



3978 dark grey engobed

Δ < 3 % · DIN EN 14411, Gr. A₁



3976 grey-mix engobed

Δ < 3 % · DIN EN 14411, Gr. A₁



3923 red engobed

Δ < 3 % · DIN EN 14411, Gr. A₁



3927 dark red engobed

Δ < 3 % · DIN EN 14411, Gr. A₁



Completely frost resistant
25 year guarantee*



Suitable for
insulation systems



Wheaterproof



Economic



In compliance
with DIN EN



Fade-free and
colourfast



Easy maintenance
and hygienic



Ecofriendly



Resistant to
chemicals



Glow-resistant
and fireproof



Anti-static



Resource-saving extruded.



Energy-efficiently manufactured.



Sustainable building material.



High-quality facade covering for installation systems.



Durable and economical.



Frost resistance 25 year guarantee*

KONTUR EG product details

DIN EN 14411
Clinker brick slips, extruded
test result precision
test result nature



CLINKER BRICK SLIP



CLINKER BRICK SLIP



CORNER



LINTEL ANGLE



CLINKER BRICK SLIP



CORNER



LINTEL ANGLE

NOMINAL SIZE IN CM	DF	Long format		DF	DF	NF	NF	NF						
PRODUCTION SIZE IN MM	240 x 52 x 12	440 x 52 x 12		240 x 115 x 52 x 12	240 x 115 x 52 x 12	240 x 71 x 12	240 x 115 x 71 x 12	240 x 115 x 71 x 12						
COLOUR	PG	ARTICLE	PG	ARTICLE	PG	ARTICLE	PG	ARTICLE	PG	ARTICLE				
3915 BEIGE ENG.	26	95044-002	466	95044-011	754	95044-014	779	95044-023	26	95044-044	752	95044-069	778	95044-093
3974 GREY ENG.		95044-004		95044-012		95044-016		95044-025		95044-046		95044-071		95044-144
3913 BEIGE-FLASHED		95044-003		95044-015		95044-024		95044-045		95044-070		95044-148		
3975 GREY-FLASHED		95044-005		95044-017		95044-026		95044-047		95044-072		95044-141		
3912 LIGHT BEIGE ENG.		95044-006		95044-018		95044-027								
3976 GREY-MIX ENG.		95044-009		95044-021		95044-030								
3978 DARK GREY ENG.		95044-010		95044-022		95044-031								
3923 RED ENG.		95044-007		95044-019		95044-028								
3927 DARK RED ENG.		95044-008		95044-020		95044-029								
PIECE	kg	0,312	0,567	0,462	0,898	0,427	0,618	1,070						
	Piece	52	32	14	6	39	14	4						
BUNDLE	m ² /lm	0,81	0,93	0,87	1,50	0,81	1,12	1,00						
	kg	16,224	18,144	6,468	5,388	16,653	8,652	4,280						
PALLET	Piece	4.212	1.216	910	684	3.159	910	456						
	m ² /lm	65,81	35,18	56,42	171,00	65,81	72,80	114,00						
	kg	1.314	689	420	614	1.349	562	488						
	Bundle	81	38	65	114	81	65	114						
M ² /LM	Piece (incl. joint)	64,00	34,57	16,13	4,00	48,00	12,50	4,00						
	kg	19,968	19,601	7,452	3,592	20,496	7,725	4,280						
DISCOUNT ON PALLETS	yes	yes	yes	yes	yes	yes	yes	yes						
SURCHARGE ¹⁾	yes	yes	yes	yes	yes	yes	yes	yes						

PG = Price group (please see price list 2023) ¹⁾ = Minimum quantity: each open box will incur a surcharge. The squareness of angled aprons is defined in the Ströher factory standard. The permissible tolerance value α ±1,5°. For more information, see the section „General requirements and tests“ on page 180. The formats shown are illustrative drawings and are not binding. All information without guarantee.

* Ströher grants a 25-year guarantee on frost resistance for the following selected coarse ceramic products and series when laid professionally by a qualified specialist company: Roccia Next, Selected, Gravel Blend, Epos, Aera, Roccia, Terra, Stalotec, Farbklang, Nuancist, Brickwerk, Wasserbrand, Kontur, Riegel 50, Steinlinge, Glanzstücke, Zeitlos and Keravette.

KONTUR

Expressive. Next-level brick slips. The best of both worlds.

Firings and formats



3916 beige-fired
Δ < 3 % · DIN EN 14411, Gr. A₁



3973 grey-fired
Δ < 3 % · DIN EN 14411, Gr. A₁



3914 sand-fired
Δ < 3 % · DIN EN 14411, Gr. A₁



3944 brown-fired
Δ < 3 % · DIN EN 14411, Gr. A₁





Resource-saving extruded.



Energy-efficiently manufactured.



Sustainable building material.



High-quality facade covering for installation systems.



Durable and economical.



Frost resistance 25 year guarantee*

KONTUR CG product details

DIN EN 14411
Clinker brick slips, extruded
test result precision



CLINKER BRICK SLIP



CORNER



LINTEL ANGLE



CLINKER BRICK SLIP



CORNER



LINTEL ANGLE

NOMINAL SIZE IN CM	DF	DF	DF	NF	NF	NF						
PRODUCTION SIZE IN MM	240 x 52 x 12	240 x 115 x 52 x 12	240 x 115 x 52 x 12	240 x 71 x 12	240 x 115 x 71 x 12	240 x 115 x 71 x 12						
COLOUR	PG	ARTICLE	PG	ARTICLE	PG	ARTICLE	PG	ARTICLE	PG	ARTICLE		
3916 BEIGE-FIRED	26	95044-032	754	95044-036	779	95044-040	26	95044-048	752	95044-073	778	95044-097
3914 SAND-FIRED		95044-033		95044-037		95044-041		95044-049		95044-074		95044-098
3973 GREY-FIRED		95044-034		95044-038		95044-042		95044-143		95044-075		95044-099
3944 BROWN-FIRED		95044-035		95044-039		95044-043		95044-051		95044-149		95044-150
PIECE	kg	0,312	0,462	0,898	0,427	0,618	1,070					
	Piece	52	14	6	39	14	4					
BUNDLE	m ² /lm	0,81	0,87	1,50	0,81	1,12	1,00					
	kg	16,224	6,468	5,388	16,653	8,652	4,280					
PALLET	Piece	4.212	910	684	3.159	910	456					
	m ² /lm	65,81	56,42	171,00	65,81	72,80	114,00					
	kg	1.314	420	614	1.349	562	488					
	Bundle	81	65	114	81	65	114					
M ² /LM	Piece (incl. joint)	64,00	16,13	4,00	48,00	12,50	4,00					
	kg	19,968	7,452	3,592	20,496	7,725	4,280					
DISCOUNT ON PALLETS	yes	yes	yes	yes	yes	yes	yes					
SURCHARGE ¹⁾	yes	yes	yes	yes	yes	yes	yes					

PG = Price group (please see price list 2023) ¹⁾ = Minimum quantity: each open box will incur a surcharge. The squareness of angled aprons is defined in the Ströher factory standard. The permissible tolerance value $\alpha \pm 1,5^\circ$. For more information, see the section „General requirements and tests“ on page 180. The formats shown are illustrative drawings and are not binding. All information without guarantee.

* Ströher grants a 25-year guarantee on frost resistance for the following selected coarse ceramic products and series when laid professionally by a qualified specialist company: Roccia Next, Selected, Gravel Blend, Epos, Aera, Roccia, Terra, Stalotec, Farbklang, Nuancist, Brickwerk, Wasserbrand, Kontur, Riegel 50, Steinlinge, Glanzstücke, Zeitlos und Keravette.



4577 aschgrau DF



BRICKWERK

Expressive coal firing and ring furnace look, innovatively accented.

Authentic coal firing and ring furnace contouring on full body.

Intensive colouring, pronounced bulges and prints, set marks, burn outs and sooty smoke flags on the firing skin: authentic and innovative, Brickwerk reinterprets the typical coal firing and ring furnace look of historic clinker bricks.

Entirely without aggregates such as coal or peat, the traditional clinker production is revolutionised with state-of-the-art, high-tech glaze technology. Innovative surface technology powerfully accentuates the surface of the Brickwerk clinker brick slips, which are coloured right through. Haptic as well as optical effects. Intense colour brilliance; full of character. While also being completely natural and resource-friendly. Brickwerk is available in six colours in NF/DF format.



240 x 52 x 12 mm
DF

240 x 71 x 12 mm
NF



BRICKWERK

Authentic. Intensive colour brilliance. Full-body.

Firings and formats



4585 eisenschwarz
 Δ < 3 % · DIN EN 14411, Gr. AII_{gr}



4522 kupferrot
 Δ < 6 % · DIN EN 14411, Gr. AII_{gr}



4577 aschgrau
 Δ < 3 % · DIN EN 14411, Gr. AII_{gr}



4526 flammenrot
 Δ < 6 % · DIN EN 14411, Gr. AII_{gr}



4545 moorbraun
 Δ < 3 % · DIN EN 14411, Gr. AII_{gr}



4528 violettrot
 Δ < 6 % · DIN EN 14411, Gr. AII_{gr}



Completely frost resistant
 25 year guarantee*



Suitable for
 insulation systems



Weatherproof



Economic



In compliance
 with DIN EN



Fade-free and
 colourfast



Easy maintenance
 and hygienic



Ecofriendly



Resistant to
 chemicals



Glow-resistant
 and fireproof



Anti-static



Resource-saving extruded.



Energy-efficiently manufactured.



Sustainable building material.



High-quality facade covering for installation systems.



Durable and economical.



Frost resistance 25 year guarantee*

BRICKWERK product details

DIN EN 14411
Clinker brick slips, extruded
test result precision



CLINKER BRICK SLIP



CORNER



LINTEL ANGLE



CLINKER BRICK SLIP



CORNER



LINTEL ANGLE

NOMINAL SIZE IN CM		DF	DF	DF	NF	NF	NF						
PRODUCTION SIZE IN MM		240 x 52 x 12		240 x 115 x 52 x 12		240 x 115 x 52 x 12		240 x 71 x 12		240 x 115 x 71 x 12		240 x 115 x 71 x 12	
COLOUR	PG	ARTICLE	PG	ARTICLE	PG	ARTICLE	PG	ARTICLE	PG	ARTICLE	PG	ARTICLE	
● 4585 EISENSCHWARZ	445	95052-002	768	95052-014	804	95052-026	445	95052-008	767	95052-020	83	95052-032	
● 4577 ASCHGRAU		95052-003		95052-015		95052-027		95052-009		95052-021		95052-033	
● 4545 MOORBRAUN		95052-004		95052-016		95052-028		95052-010		95052-022		95052-034	
● 4522 KUPFERROT	448	95052-005	764	95052-017	806	95052-029	448	95052-011	776	95052-023	84	95052-035	
● 4526 FLAMMENROT		95052-006		95052-018		95052-030		95052-012		95052-024		95052-036	
● 4528 VIOLETTROT		95052-007		95052-019		95052-031		95052-013		95052-025		95052-037	
PIECE	kg	0,312 / 0,330 ²⁾		0,462 / 0,490 ²⁾		0,898 / 0,951 ²⁾		0,427 / 0,452 ²⁾		0,618 / 0,655 ²⁾		1,070 / 1,135 ²⁾	
	Piece	52		14		6		39		14		4	
BUNDLE	m ² /lm	0,81		0,87		1,50		0,81		1,12		1,00	
	kg	16,224 / 17,160 ²⁾		6,468 / 6,860 ²⁾		5,388 / 5,706 ²⁾		16,653 / 17,628 ²⁾		8,652 / 9,170 ²⁾		4,280 / 4,540 ²⁾	
PALLET	Piece	4,212		910		684		3,159		910		456	
	m ² /lm	65,81		56,42		171,00		65,81		72,80		114,00	
	kg	1,314 / 1,390 ²⁾		420 / 446 ²⁾		614 / 650 ²⁾		1,349 / 1,428 ²⁾		562 / 596 ²⁾		488 / 518 ²⁾	
	Bundle	81		65		114		81		65		114	
M ² /LM	Piece (incl. joint)	64,00		16,13		4,00		48,00		12,50		4,00	
	kg	19,968 / 21,120 ²⁾		7,452 / 7,904 ²⁾		3,592 / 3,804 ²⁾		20,496 / 21,696 ²⁾		7,725 / 8,188 ²⁾		4,280 / 4,540 ²⁾	
DISCOUNT ON PALLETS	yes		yes		yes		yes		yes		yes		
SURCHARGE ¹⁾	yes		yes		yes		yes		yes		yes		

PG = Price group (please see price list 2023) ¹⁾ = Minimum quantity; each open box will incur a surcharge. ²⁾ = Weight indications for the colours 4522 kupferrot, 4526 flammenrot und 4528 violettrot. The squareness of angled aprons is defined in the Ströher factory standard. The permissible tolerance value $\alpha \pm 1,5^\circ$. For more information, see the section „General requirements and tests“ on page 180.

The formats shown are illustrative drawings and are not binding. All information without guarantee.

* Ströher grants a 25-year guarantee on frost resistance for the following selected coarse ceramic products and series when laid professionally by a qualified specialist company: Roccia Next, Selected, Gravel Blend, Epos, Aera, Roccia, Terra, Stalotec, Farbklang, Nuancist, Brickwerk, Wasserbrand, Kontur, Riegel 50, Steinlinge, Glanzstücke, Zeitlos und Keravette.



4074 silver-grey used look bar shape

RIEGEL 50

Voguish long format. For a particularly straight-lined design.

**Blue-fired, sinter patina or finely tuned „used look“.
Simple and yet exhilarating in state-of-the-art format.**

Successful contemporary architecture requires more than just a particularly straightlined design today. Contemporary architecture emphasizes intelligent building technology on the inside. The exterior features a state-of-the-art building skin that breathes with natural materials.

Riegel 50 combines the archaic look of blue-fired, a muted sintered patina, or a subtle „used look“ with the stylish slenderness of the long format in a very in vogue way.

Because materials with character and soul are trending. Architecturally, they provide an exciting counterpoint to modern, minimalist design. For the soul, they are a soothing anchor. A base that leaves room for the genuine and authentic. Age and wear are allowed to become apparent here. Strong in character, they create a sense of security in a modern subtle way.



490 x 40 x 14 mm
Bar shape



240 x 52 x 14 mm
DF

RIEGEL 50

In vogue. Line-emphasized. Extra-long.

Firings and formats



4074 silver-grey used look
 $\Delta < 3\%$ · DIN EN 14411, Gr. A₁

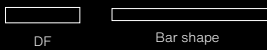

3286 silver-black
 $\Delta < 3\%$ · DIN EN 14411, Gr. A₁

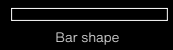

3244 brown-blue
 $\Delta < 3\%$ · DIN EN 14411, Gr. A₁

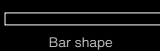

3284 black-blue
 $\Delta < 3\%$ · DIN EN 14411, Gr. A₁

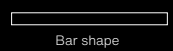

Completely frost resistant
 25 year guarantee*



Suitable for
 insulation systems



Wheaterproof



Economic



In compliance
 with DIN EN



Fade-free and
 colourfast



Easy maintenance
 and hygienic



Ecofriendly



Resistant to
 chemicals



Glow-resistant
 and fireproof



Anti-static



Resource-saving extruded.



Energy-efficiently manufactured.



Sustainable building material.



High-quality facade covering for installation systems.



Durable and economical.



Frost resistance 25 year guarantee*

RIEGEL 50 product details

DIN EN 14411
Clinker brick slips, extruded
test result precision
test result nature



CLINKER BRICK SLIP



CORNER



CLINKER BRICK SLIP



CORNER

NOMINAL SIZE IN CM		Bar shape		-		DF		DF	
PRODUCTION SIZE IN MM		490 x 40 x 14		240 x 115 x 40 x 14		240 x 52 x 14		240 x 115 x 52 x 14	
COLOUR	PG	ARTICLE	PG	ARTICLE	PG	ARTICLE	PG	ARTICLE	
4074 SILVER-GREY USED LOOK		95135-002		95035-011	29	95135-006	774	95035-010	
3244 BROWN-BLUE	487	95135-003	774	95035-007					
3284 BLACK-BLUE		95135-004		95035-008					
3286 SILVER-BLACK		95135-005		95035-009					
PIECE		kg		0,652	0,456	0,396	0,585		
	Piece	40	21	30	14				
BUNDLE	m ² /lm	1,04	1,09	0,47	0,87				
	kg	26,080	9,576	11,880	8,190				
PALLET	Piece	1.320	1.365	2.160	910				
	m ² /lm	34,46	70,98	33,75	56,42				
	kg	861	622	855	532				
	Bundle	33	65	72	65				
M ² /LM	Piece (incl. joint)	38,31	19,23	64,00	16,13				
	kg	24,978	8,769	25,344	9,436				
DISCOUNT ON PALLETS		yes	yes	yes	yes				
SURCHARGE ¹⁾		yes	yes	yes	yes				

PG = Price group (please see price list 2023) ¹⁾ = Minimum quantity; each open box will incur a surcharge. The squareness of angled aprons is defined in the Ströher factory standard. The permissible tolerance value $\alpha \pm 1,5^\circ$. For more information, see the section „General requirements and tests“ on page 180. The formats shown are illustrative drawings and are not binding. All information without guarantee.

* Ströher grants a 25-year guarantee on frost resistance for the following selected coarse ceramic products and series when laid professionally by a qualified specialist company: Roccia Next, Selected, Gravel Blend, Epos, Aera, Roccia, Terra, Stalotec, Farbklang, Nuancist, Brickwerk, Wasserbrand, Kontur, Riegel 50, Steinlinge, Glanzstücke, Zeitlos und Keravette.



2725 shabbyrot NF

STEINLINGE

**Up to date. Visible brickwork with antique look.
Modern handling.**

**Antique look with easy-to-lay, reliable sizing;
energy-conscious myth appearance.**

Steinlinge are the descendants, adapted to contemporary clinker standards of the fine old brick era. Steinlinge give a facade the charm of times gone by, while they are at the same time easy to lay thanks to their uniform size.

Fired to be frostproof in high-tech sintering furnaces at 1.200 °C, Steinlinge continue the tradition of masonry with added weatherproofing. These clinker brick slips are not only permanently easy to clean and use, but in combination with an EIFS system, they are also compliant with all current energy-saving regulations.



240 x 71 x 14 mm
NF

STEINLINGE

Hand-made look. Exactly sized. Mythical.

Firings and formats



2712 silberbeige

Δ < 3 % · DIN EN 14411, Gr. A₁

NF



2714 amberbeige

Δ < 3 % · DIN EN 14411, Gr. A₁

NF



2725 shabbyrot

Δ < 3 % · DIN EN 14411, Gr. A₁

NF



2775 platingrau

Δ < 3 % · DIN EN 14411, Gr. A₁

NF



2785 platinschwarz

Δ < 6 % · DIN EN 14411, Gr. A₁, Test1

NF



2747 platinbraun

Δ < 3 % · DIN EN 14411, Gr. A₁

NF



Completely frost resistant
25 year guarantee*



Suitable for
insulation systems



Wheaterproof



Economic



In compliance
with DIN EN



Fade-free and
colourfast



Easy maintenance
and hygienic



Ecofriendly



Resistant to
chemicals



Glow-resistant
and fireproof



Anti-static



Resource-saving extruded.



Energy-efficiently manufactured.



Sustainable building material.



High-quality facade covering for installation systems.



Durable and economical.



Frost resistance 25 year guarantee*

STEINLINGE product details

DIN EN 14411
Clinker brick slips, extruded
test result precision



CLINKER
BRICK SLIP



CORNER

NOMINAL SIZE IN CM		NF	NF	
PRODUCTION SIZE IN MM		240 x 71 x 14	240 x 115 x 71 x 14	
COLOUR	PG	ARTICLE	PG	ARTICLE
2712 SILBERBEIGE	39	95129-002	772	95029-008
2714 AMBERBEIGE		95129-003		95029-009
2725 SHABBYROT		95129-004		95029-010
2775 PLATINGRAU		95129-005		95029-011
2785 PLATINSCHWARZ		95129-006		95029-012
2747 PLATINBRAUN		95129-007		95029-013
PIECE		kg		0,525
	Piece	20	14	
BUNDLE	m ² /lm	0,42	1,12	
	kg	10,500	10,724	
	Piece	1.920	910	
PALLET	m ² /lm	40,00	72,80	
	kg	1.008	697	
	Bundle	96	65	
M ² /LM	Piece (incl. joint)	48,00	12,50	
	kg	25,200	9,575	
DISCOUNT ON PALLETS		yes	yes	
SURCHARGE ¹⁾		yes	yes	

PG = Price group (please see price list 2023) ¹⁾ = Minimum quantity: each open box will incur a surcharge. The squareness of angled aprons is defined in the Ströher factory standard. The permissible tolerance value $\alpha \pm 1,5^\circ$. For more information, see the section „General requirements and tests“ on page 180. The formats shown are illustrative drawings and are not binding. All information without guarantee.

* Ströher grants a 25-year guarantee on frost resistance for the following selected coarse ceramic products and series when laid professionally by a qualified specialist company: Roccia Next, Selected, Gravel Blend, Epos, Aera, Roccia, Terra, Stalotec, Farbklang, Nuancist, Brickwerk, Wasserbrand, Kontur, Riegel 50, Steinlinge, Glanzstücke, Zeitlos und Keravette.



GLANZSTÜCKE

Retro-brick with sheen effect. Extra slim. Long format.

Extruded vintage look with shine effect and with a used look texture. Quick slurry application.

Extra slim retro brick in long format 440 x 52 x 14 mm. Cleaner vintage look with unobtrusive shine effect. With a used look texture, but still with a smooth surface appearance.

This brick ensures quick application for laying and turns facades into unmistakable pieces de resistance without the need for joints. And as a high-tech clinker brick slip in high sinter quality, it's a piece de resistance of energy-conscious "shell" design.



440 x 52 x 14 mm
Long format

GLANZSTÜCKE

Vintage Look. Shine effect. Extra slim.

Firings and formats



2484 Glanzstück N° 1
 $\Delta < 3\%$ · DIN EN 14411, Gr. A₁

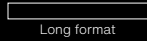

Long format



2426 Glanzstück N° 2
 $\Delta < 3\%$ · DIN EN 14411, Gr. A₁

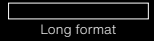

Long format



2473 Glanzstück N° 3
 $\Delta < 6\%$ · DIN EN 14411, Gr. A₁, -_{test1}

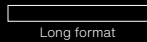

Long format



2411 Glanzstück N° 4
 $\Delta < 6\%$ · DIN EN 14411, Gr. A₁, -_{test1}

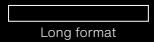

Long format



2487 Glanzstück N° 6
 $\Delta < 3\%$ · DIN EN 14411, Gr. A₁

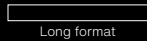

Long format



2475 Glanzstück N° 7
 $\Delta < 3\%$ · DIN EN 14411, Gr. A₁

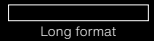

Long format



Completely frost resistant
25 year guarantee*



Suitable for
insulation systems



Wheaterproof



Economic



In compliance
with DIN EN



Fade-free and
colourfast



Easy maintenance
and hygienic



Ecofriendly



Resistant to
chemicals



Glow-resistant
and fireproof



Anti-static



Resource-saving extruded.



Energy-efficiently manufactured.



Sustainable building material.



High-quality facade covering for installation systems.



Durable and economical.



Frost resistance 25 year guarantee*

GLANZSTÜCKE product details

DIN EN 14411
Clinker brick slips, extruded
test result nature



CLINKER
BRICK SLIP



CORNER

NOMINAL SIZE IN CM		Long format	DF	
PRODUCTION SIZE IN MM		440 x 52 x 14	240 x 115 x 52 x 14	
COLOUR	PG	ARTICLE	PG	ARTICLE
2484 GLANZSTÜCK NO. 1	464	95126-002	774	95026-009
2426 GLANZSTÜCK NO. 2		95126-003		95026-010
2473 GLANZSTÜCK NO. 3		95126-004		95026-011
2411 GLANZSTÜCK NO. 4		95126-005		95026-012
2487 GLANZSTÜCK NO. 6		95126-006		95026-013
2475 GLANZSTÜCK NO. 7		95126-007		95026-014
PIECE		kg		0,725
	Piece	30	14	
BUNDLE	m ² /lm	0,87	0,90	
	kg	21,750	7,812	
PALLET	Piece	1.200	910	
	m ² /lm	34,71	58,22	
	kg	870	508	
	Bundle	40	65	
M ² /LM	Piece (incl. joint)	34,57	15,63	
	kg	25,063	8,722	
DISCOUNT ON PALLETS		yes	yes	
SURCHARGE ¹⁾		yes	yes	

PG = Price group (please see price list 2023) ¹⁾ = Minimum quantity: each open box will incur a surcharge. The squareness of angled aprons is defined in the Ströher factory standard. The permissible tolerance value $\alpha \pm 1,5^\circ$. For more information, see the section „General requirements and tests“ on page 180. The formats shown are illustrative drawings and are not binding. All information without guarantee.

* Ströher grants a 25-year guarantee on frost resistance for the following selected coarse ceramic products and series when laid professionally by a qualified specialist company: Roccia Next, Selected, Gravel Blend, Epos, Aera, Roccia, Terra, Stalotec, Farbklang, Nuancist, Brickwerk, Wasserbrand, Kontur, Riegel 50, Steinlinge, Glanzstücke, Zeitlos und Keravette.



ZEITLOS

The high tech patina brick-slip in sintered clinker quality and premium strength.

Archaic appearance with dimensional precision for easy laying, energy-aware faced masonry look.

Brick expressionism: old exposed brickwork is having a renaissance. It is almost as if we are happy to have facades crumbling both inside and out. Also mixed. Two high-end sizes in long format 400 x 71 mm and bar shape 400 x 35 mm as well as in NF format and DF format allow this trend look. Zeitlos, the extra strong 14 mm thick patina brick slip in quality frost-proof high-tech extruded sinter quality.

There are all sorts of different placing options with variable joint widths and individually customised colour ranges based on eleven tailored colour tones providing lots of unique styles. Even with its natural edges, Zeitlos is safe to apply and easy-care, making it right on trend for facade design even when it comes to the environment, energy and costs.



240 x 52 x 14 mm
DF



240 x 71 x 14 mm
NF



400 x 35 x 14 mm
bar shape



400 x 71 x 14 mm
Long format

ZEITLOS

Archaic. Technically perfect. Energy-conscious.

Firings and formats



1975 austerrauch
 $\Delta < 3\%$ · DIN EN 14411, Gr. A₁

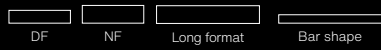

1911 kalkbrand
 $\Delta < 3\%$ · DIN EN 14411, Gr. A₁

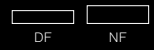

1985 kohleglanz
 $\Delta < 3\%$ · DIN EN 14411, Gr. A₁

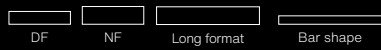

1913 kupferschmelz
 $\Delta < 3\%$ · DIN EN 14411, Gr. A₁

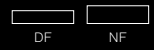

1917 sandschmelz
 $\Delta < 3\%$ · DIN EN 14411, Gr. A₁



1914 bronzebruch
 $\Delta < 3\%$ · DIN EN 14411, Gr. A₁



Completely frost resistant
 25 year guarantee*



Suitable for
 insulation systems



Wheaterproof



Economic



In compliance
 with DIN EN



Fade-free and
 colourfast



Easy maintenance
 and hygienic



Ecofriendly



Resistant to
 chemicals



Glow-resistant
 and fireproof



Anti-static



1926 eisenrost

Δ < 3 % · DIN EN 14411, Gr. A₁



1988 onyxstaub

Δ < 3 % · DIN EN 14411, Gr. A₂

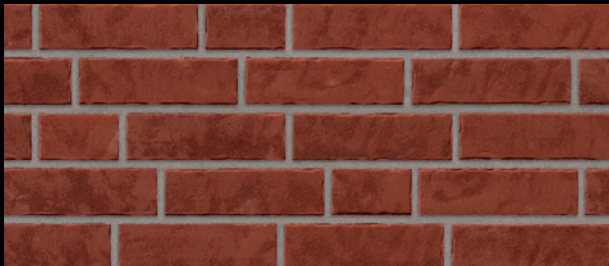

1925 erdfeuer

Δ < 3 % · DIN EN 14411, Gr. A₁



1947 sepiaquarz

Δ < 3 % · DIN EN 14411, Gr. A₁



1923 backstein

Δ < 3 % · DIN EN 14411, Gr. A₁



ZEITLOS

Archaic.
Technically perfect.
Energy-conscious.





Resource-saving extruded.



Energy-efficiently manufactured.



Sustainable building material.



High-quality facade covering for installation systems.



Durable and economical.



Frost resistance 25 year guarantee*

ZEITLOS product details

DIN EN 14411
Clinker brick slips, extruded
test result precision
test result nature



CLINKER BRICK SLIP



CORNER



CLINKER BRICK SLIP



CLINKER BRICK SLIP



CORNER



CLINKER BRICK SLIP



CORNER

NOMINAL SIZE IN CM	DF	DF	NF	Long format	NF	Bar shape	-								
PRODUCTION SIZE IN MM	240 x 52 x 14	240 x 115 x 52 x 14	240 x 71 x 14	400 x 71 x 14	240 x 115 x 71 x 14	400 x 35 x 14	240 x 115 x 35 x 14								
COLOUR	PG	ARTICLE	PG	ARTICLE	PG	ARTICLE	PG	ARTICLE	PG	ARTICLE					
1913 KUPFERSCHMELZ	413	95121-013	79	95021-039	413	95121-002	775	95021-028	477	95121-026	773	95021-050			
1914 BRONZEBRUCH		95121-014		95021-040		95121-003		95021-029				95021-051			
1925 ERDFEUER		95121-015		95021-041		95121-004		95021-030				95021-052			
1911 KALKBRAND		95121-016		95021-042		95121-005		95021-031				95021-053			
1926 EISENROST		95121-017		95021-043		95121-006		95021-032				95021-054			
1917 SANDSCHMELZ		95121-018		95021-044		95121-007		95021-033				95021-055			
1923 BACKSTEIN		95121-019		95021-045		95121-008		95021-034				95021-056			
1975 AUSTERRAUCH		95121-020		95021-046		95121-009		95021-035				95021-057			
1985 KOHLEGLANZ		95121-021		95021-047		95121-010		95021-036				95021-058			
1988 ONYXSTAUB		95121-022		95021-048		95121-011		95021-037				95021-059			
1947 SEPIAQUARZ		95121-023		95021-049		95121-012		95021-038				95021-060			
PIECE		kg		0,389		0,560		0,525				0,879	0,771	0,465	0,386
		Piece		30		14		20				20	14	36	21
BUNDLE	m ² /lm	0,47	0,87	0,42	0,68	1,12	0,70	0,99							
	kg	11,670	7,840	10,500	17,580	10,794	16,740	8,106							
PALLET	Piece	2.160	910	1.920	960	910	1.728	1.365							
	m ² /lm	33,75	56,42	40,00	32,83	72,80	33,46	64,08							
	kg	840	510	1.008	844	702	804	527							
	Bundle	72	65	96	48	65	48	65							
M ² /LM	Piece (incl. joint)	64,00	16,13	48,00	29,24	12,50	51,64	21,30							
	kg	24,896	9,033	25,200	25,702	9,638	24,013	8,222							
DISCOUNT ON PALLETS	yes	yes	yes	yes	yes	yes	yes	yes							
SURCHARGE ¹⁾	yes	yes	yes	yes	yes	yes	yes	yes							

PG = Price group (please see price list 2023) ¹⁾ = Minimum quantity: each open box will incur a surcharge. The squareness of angled aprons is defined in the Ströher factory standard. The permissible tolerance value $\alpha \pm 1,5^\circ$. For more information, see the section „General requirements and tests“ on page 180. The formats shown are illustrative drawings and are not binding. All information without guarantee.

* Ströher grants a 25-year guarantee on frost resistance for the following selected coarse ceramic products and series when laid professionally by a qualified specialist company: Roccia Next, Selected, Gravel Blend, Epos, Aera, Roccia, Terra, Stalotec, Farbklang, Nuancist, Brickwerk, Wasserbrand, Kontur, Riegel 50, Steinlinge, Glanzstücke, Zeitlos und Keravette.

The number required per m2 for installing mixed long and bar sizes varies depending on the actual mixing ratio, the arrangement of the sizes and on design factors. The following recommendation is therefore only indicative and not binding. Requirements per m²: Format 400 x 71 x 14 mm: 19 pieces, Format 400 x 35 x 14 mm: 24 pieces.



KERAVETTE

**Against wind and weather.
And too high energy costs.**

**Also regarding cost-effectiveness. Unobtrusive and yet
still impressive.**

Keravette gives a facade a new unmistakable and individual look. No wonder the word "facade" has been adopted from the Italian word "faccia" meaning "face". 10 beautiful colour tones in NF-format give you an enormous choice of options. So each facade quite easily becomes unmistakable. The material thickness of 11 mm means this classic among clinker brick slips is not only light but, thanks to the especially high firing temperature, it is also extremely robust. Together with modern thermal insulation, they are also hard to resist when it comes to price.



240 x 71 x 11 mm
NF

KERAVETTE

Irresistible. Uncomplicated. Unobtrusive.

Firings and formats



0707 white

Δ < 6% · DIN EN 14411, Gr. AII₂-Tst1

NF

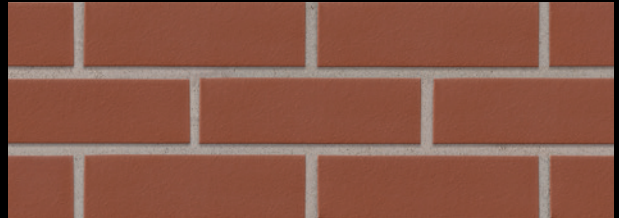

0725 patrician red

Δ < 3% · DIN EN 14411, Gr. AI₂

NF



0741 brown

Δ < 3% · DIN EN 14411, Gr. AI₂

NF

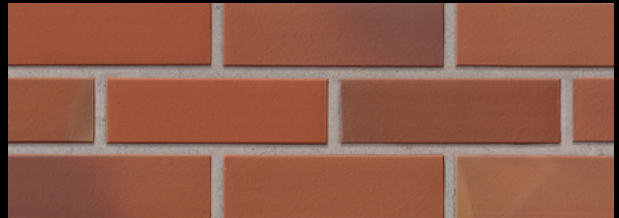

0727 patrician red flashed

Δ < 3% · DIN EN 14411, Gr. AI₂

NF

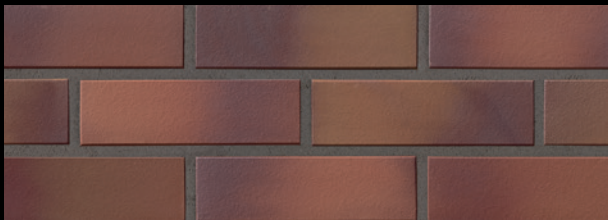

0728 palace

Δ < 3% · DIN EN 14411, Gr. AI₂

NF



0785 graphite

Δ < 6% · DIN EN 14411, Gr. AII₂-Tst1

NF



0729 achatblue flashed

Δ < 3% · DIN EN 14411, Gr. AI₂

NF



0783 metallic black

Δ < 3% · DIN EN 14411, Gr. AI₂

NF



0747 sherry

Δ < 3% · DIN EN 14411, Gr. AI₂

NF



0788 royal

Δ < 3% · DIN EN 14411, Gr. AI₂

NF



Completely frost resistant
25 year guarantee*



Suitable for
insulation systems



Wheaterproof



Economic



In compliance
with DIN EN



Fade-free and
colourfast



Easy maintenance
and hygienic



Ecofriendly



Resistant to
chemicals



Glow-resistant
and fireproof



Anti-static



Resource-saving extruded.



Energy-efficiently manufactured.



Sustainable building material.



High-quality facade covering for installation systems.



Durable and economical.



Frost resistance 25 year guarantee*

KERAVETTE product details

DIN EN 14411
Clinker brick slips, extruded
test result precision



CLINKER BRICK SLIP



CORNER



CORNER

NOMINAL SIZE IN CM		NF	NF	NF
PRODUCTION SIZE IN MM		240 x 71 x 11	240 x 115 x 71 x 11	175 x 52 x 71 x 11
COLOUR	PG	ARTICLE	PG	ARTICLE
0725 PATRICIAN RED	35	95109-002	77	95009-012
0727 PATRICIAN RED FLASHED		95109-003		95009-013
0785 GRAPHITE		95109-004		95009-014
0783 METALLIC BLACK	37	95109-005	77	95009-015
0729 ACHATBLUE FLASHED		95109-006		95009-016
0728 PALACE		95109-007		95009-017
0741 BROWN		95109-008		95009-018
0707 WHITE		95109-009		95009-019
0788 ROYAL	76	95109-010	76	95009-020
0747 SHERRY		95109-011		95009-021
PIECE	kg	0,399	0,638	0,359
	Piece	26	16	28
BUNDLE	m ² /lm	0,52	1,28	2,24
	kg	10,374	10,208	10,052
PALLET	Piece	2.496	1.040	1.680
	m ² /lm	49,92	83,20	134,40
	kg	996	664	603
	Bundle	96	65	60
M ² /LM	Piece (incl. joint)	50,00	12,50	12,50
	kg	19,950	7,975	4,488
DISCOUNT ON PALLETS		yes	yes	yes
SURCHARGE ¹⁾		yes	yes	yes

PG = Price group (please see price list 2023) ¹⁾ = Minimum quantity: each open box will incur a surcharge. The squareness of angled aprons is defined in the Ströher factory standard. The permissible tolerance value $\alpha \pm 1,5^\circ$. For more information, see the section „General requirements and tests“ on page 180. The formats shown are illustrative drawings and are not binding. All information without guarantee.

* Ströher grants a 25-year guarantee on frost resistance for the following selected coarse ceramic products and series when laid professionally by a qualified specialist company: Roccia Next, Selected, Gravel Blend, Epos, Aera, Roccia, Terra, Stalotec, Farbklang, Nuancist, Brickwerk, Wasserbrand, Kontur, Riegel 50, Steinlinge, Glanzstücke, Zeitlos und Keravette.



Proper processing of **CLINKER BRICK SLIPS** on **FACADES**

Clinker brick slips on outdoor facades require professional installation in accordance with the following standard:

- DIN 18515-1 Exterior wall cladding / May 2015

The specified recommendation is exemplary for the purpose of simplified, schematic visualization only. Complaints resulting from improper installation cannot be regulated by the manufacturer.

PREPARING

Prior to bonding the brick slips, the visible dimensions of the window and door lintels need to be measured. In the rarest cases, the reveal and lintel dimensions correspond to the standardized brick slips dimensions. For this reason, it is necessary to adjust the brick slip bond. The determined visible dimensions are then also transferred to the corners of the wall.

Watch the processing
video on YouTube now.

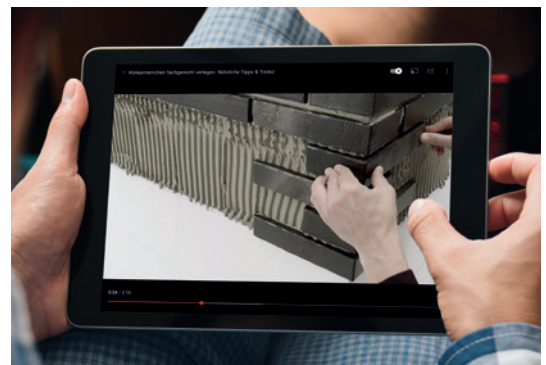

PROCESSING

After dividing the visible heights at the wall corners, the corner brick slips at the outside corners are processed using the floating-buttering method. "Floating" describes the application of the adhesive with a notched trowel in the center bed. „Buttering“ is the process of covering the back of the clinker brick slip with adhesive using a trowel. Before the surface is processed, the wall layout should first be determined. In most cases, a "wild" bond is recommended, where five heads are incorporated in one square meter. The head visually replicates the face of a whole brick and is cut from the surface using a tile cutter or flex in the case of clinker brick slips.



Window lintel perfectly replicated with angles.

The corners and clinker brick slips are processed using the floating-buttering method.



Placement of the surface clinker brick slips using a line aid. The clinker brick slips are pressed into the adhesive bed.

The finished surface. After the curing time, grouting can be started.

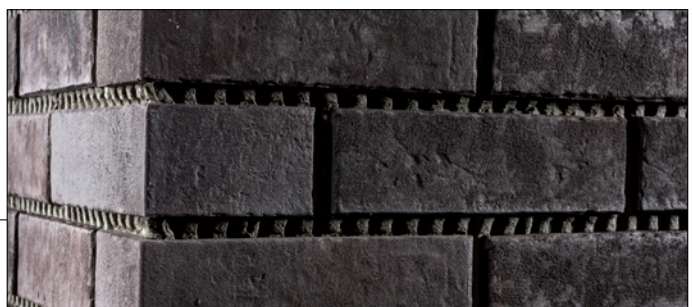

GROUTING

After the clinker brick slips have been processed, grouting can be started after an adequate curing time (observe the instructions of the mortar manufacturer). Clinker brick slips with smooth surfaces can be processed using the slurry method. There is a wide range of grouts available on the market, but some of them contain plastics and color pigments. Therefore, before selecting a grout, it is essential to consult the grout manufacturer regarding compatibility. All rough, patinated and textured surfaces are grouted conventionally with a pointing trowel and a metal float.



The grouting with a pointing trowel and a metal float in the horizontal direction.

The vertical grouts are easier to apply with a smaller trowel.



Trowel jointing can be used to create different looks.

Sweeping the grout gives it a typical structure.





The finished grout joint.
Always complete sides are grouted.

With the slurry method, the grouts are filled diagonally with the grouting or plaster float. Wall surfaces are to be processed from the top down.



The excess mortar is washed off diagonally with the help of a plaster float with a sponge or foam pad.

The finished, slurred and washed grout.



Conventional grouting with grouting tool

The following Ströher Series require conventional grouting:
Farbklang, Nuancist Brickwerk, Wasserbrand, Kontur, Riegel 50, Glanzstücke, Steinlinge und Zeitlos.

Grouting using the slurry method

The following Ströher Series can be processed using the pugging method: Keravette.

GENERAL REQUIREMENTS AND TESTS

Clinker brick slips, stoneware tiles, extruded

DIN EN 14411, Gr. AII
(enqual DIN EN 186, Part 1)
appendix B

and

DIN EN 14411, Gr. AI
(enqual DIN EN 121)
appendix A

Footnotes to tables
clinker brick slips, extruded
stoneware tiles:

¹⁾ Only applicable to tiles with straight edges.

²⁾ Due to the firing process slight deviations from the respective standard colours are unavoidable. The extent of the permissible colour deviation should be agreed by the parties concerned. This does not apply to deliberate irregularities in the colour nuances in the facial surface of extruded tiles with low water absorption (which may be unglazed, partly glazed or fully glazed and to the play of colours within a floor cladding, which is required and characteristic of the material concerned. Spots or coloured specks, which have been intentionally applied for decorative reasons, should not be regarded as defects.

³⁾ Certain tile decors have a tendency to crazing (glaze cracking). If the manufacturer draws attention to this, the test for crazing resistance according to Standard DIN EN ISO 10545-11 will not be applied.

⁴⁾ Slight colour changes should not be taken to indicate chemical attack.

⁵⁾ WA ≤ 3% appendix A ≤ 275 mm³
WA 3% ≤ 6% appendix B ≤ 393 mm³

Special note by Ströher GmbH on the Split tiles and Keraplatte®:

According to the Product Standard DIN EN 14411 frost resistance is "required, if agreed". This applies to requirements of the test according to ISO 10545-12. In addition Split tiles and Keraplatzen and terrace slabs if correctly laid satisfy the more stringent conditions in practice extending beyond those covered in the test.

House standard Rectangularity for clinker brick slips

Tolerance value according to Ströher factory standard $\alpha \pm 1,5^\circ$

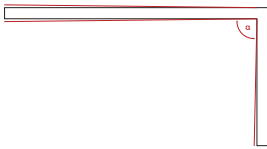

No.	Property	Requirement acc. to DIN EN 14411		Test acc. to	Test value (precision) Clinker brick slips up to edge length 30 cm, Extruded stoneware tiles	Test value (natural) Clinker brick slips from edge length 30 cm
		Precision	Natural			
Dimensions and surface quality						
1	Length and width The limiting deviation (%) of the mean value for each tile (2 or 4 edges) from the work size (W). Limiting deviation (%) of the mean value for each tile (2 or 4 edges) from the mean value from 10 specimens (20 or 40 edges).	A 1,00 max. ± 2 mm B 1,25 max. ± 2 mm ± 1,00	A, B 2,00 max. ± 4 mm ± 1,50	EN 98 ISO 10545-2	fulfilled	fulfilled
2	Thickness The limiting deviation (%) of the mean value for each tile from the work size thickness (W)	± 10				
3	Straightness of edges ¹⁾ (facial surface) The limiting deviation (%) from the straightness, taken on the corresponding work size value.	± 0,5	± 0,6			
4	Rectangularity ¹⁾ Limiting deviation (%) from rectangularity, taken on the corresponding work size value	± 1,0				
5	Surface evenness (planarity) The limiting deviation (%) from planarity a) Central curvature, taken on the diagonal calculated from the work size b) Edge curvature (camber), taken on the corresponding work size c) Twist (formerly warp), taken on the diagonal calculated from the work size	± 0,5 ± 0,5 ± 0,8	± 1,5 ± 1,5 ± 1,5			
Surface quality ²⁾		Mind. 95% free from defects		EN 98 ISO 10545-2	Free from defects which would impair the appearance of a relatively large tile surface: min. 95%	
Physical properties Water absorption (%)		A < 3 B < 6		EN 99 ISO 10545-3	fulfilled	
Bending-tensile strength N/mm ² (modulus of bending)		A ≥ 23 B ≥ 20		EN 100 ISO 10545-4	25 – 30	
Scratch hardness of surface (Mohs) a) Glazed tiles b) Unglazed tiles		mind. 5 mind. 6		EN 15771 EN 15771	6 – 7 6 – 7	
Resistance to abrasion a) Resistance to deep abrasion of unglazed tiles, volume loss in mm ³ b) Resistance to surface abrasion of glazed dry pressed and extruded tiles in Abrasion Groups 1–5		275 ⁵⁾ Die Verschleißklasse ist vom Hersteller anzugeben		EN 102 ISO 10545-6 EN 154 ISO 10545-7	see table in Delivery Programme	
Coefficient of linear thermal expansion at room temperature up to 100° C in K ⁻¹		max. 10 x 10 ⁻⁶	max. 12 x 10 ⁻⁶	EN 103 ISO 10545-8	7–8 x 10 ⁻⁶	
Thermal shock resistance		required		EN 104 ISO 10545-9	fulfilled	
Crazing resistance ³⁾ glazed dry pressed and extruded tiles		required		EN 105 ISO 10545-11	fulfilled	
Frost resistance		required, if agreed		EN 202 ISO 10545-12	fulfilled	
Chemical properties Resistance to spotting or staining agents, dry pressed and extruded tiles, Classes 1–5		glazed min. class 3, unglazed norm existing		EN 122 ISO 10545-14	glazed fulfilled, unglazed group 2	
Resistance to household chemicals and pool water additives (swimming pools) (apart from cleaning agents containing hydrofluoric acid and its compounds) Glazed and unglazed tiles, Classes A to C		mind. Class B required		ISO 10545-13 EN 122 EN 106	fulfilled	
Resistance to acids and alkalis (apart from hydrofluoric acid and its compounds) Glazed and unglazed tiles, Classes A to C		mind. Class B required		ISO 10545-13 EN 122 EN 106	fulfilled	
Antislip properties				DIN EN 16165 appendix A DIN EN 16165 appendix B	see table in Delivery Programme	

Field of application	nominal dimension requirement N		Test acc. to	Test acc. to
	7 cm ≤ N < 15 cm	N ≥ 15 cm		
Dimensions and surface quality				
Length and width Deviation of the average side length of each dry pressed and extruded tile (2 or 4 sides) from the work size (W)	± 0,9 mm	± 0,6 % max. ± 2,0 mm	EN 98 ISO 10545-2	fulfilled
Thickness Deviation of the average thickness of each dry pressed or extruded tile from the work size	± 0,5 mm	± 5 % max. ± 0,5 mm		
Straightness of sides ¹⁾ (facial surface) Maximum deviation taken on the corresponding work size	± 0,75 mm	± 0,5 % max. ± 1,5 mm		
Rectangularity ¹⁾ Maximum deviation, taken on the corresponding work size	± 0,75 mm	± 0,5 % max. ± 2,0 mm		
Flatness Maximum unit variance, a) Central curvature, taken on the diagonal calculated from the work size b) Edge curvature (camber), taken on the corresponding work size c) Twist (formerly warpage), taken on the diagonal calculated from the work size	± 0,75 mm	± 0,5 % max. ± 2,0 mm		
Surface quality ²⁾	Free from defects which would impair the appearance of a relatively large tile surface: min. 95%			
Physical properties				
Water absorption (%)	E _s ≤ 0,5 % max. single value 0,6 (Gr. Bl _s , appendix G) 0,5 % < E _s ≤ 3,0 % max. single value 3,3 (Gr. Bl _v , appendix H)		EN 99 ISO 10545-3	fulfilled
Flexural strength (modulus of bending) N/mm ²	mind. 35 (Gr. Bl _s , appendix G) mind. 30 (Gr. Bl _v , appendix H)		EN 100 ISO 10545-4	on average 35
Scratch hardness of surface (Mohs) Glazed dry pressed and extruded tiles	mind. 5		EN 15771	6-7
Resistance to abrasion Resistance to surface abrasion of dry pressed and extruded tiles in Abrasion, Group 1-5	The abrasion groups to be given by the manufacturer		EN 102 ISO 10545-6	see table in Delivery Programme
Coefficient of linear thermal expansion at room temperature up to 100° C in K ⁻¹	max. 9 x 10 ⁻⁶		EN 103 ISO 10545-8	7- x 10 ⁻⁶
Thermal shock resistance	required		EN 104 ISO 10545-9	fulfilled
Crazing resistance ³⁾ glazed dry pressed and extruded tiles	required		EN 105 ISO 10545-11	fulfilled
Frost resistance	required		EN 202 ISO 10545-12	fulfilled
Chemical properties				
Resistance to spotting or staining agents, glazed dry pressed and extruded tiles, Classes 1-3	mind. Class 3		EN 122 ISO 10545-14	fulfilled
Resistance to household chemicals and pool water additives (swimming pools) (apart from cleaners containing hydrofluoric acid and its compounds) Glazed dry pressed and extruded tiles, Classes A to C	mind. Class B		ISO 10545-13 EN 122	fulfilled
Resistance to acids and alkalis (apart from hydrofluoric acids and their compounds) Glazed dry pressed and extruded tiles, Classes A to C	mind. Class B		ISO 10545-13 EN 122	fulfilled
Antislip properties			DIN 51097 DIN 51130	see table in Delivery Programme

Porcelain stoneware tiles, dry-pressed, Ströher Living ceramic tiles, garden and terrace slabs

DIN EN 14411, Gr. Bl_s, appendix G

Footnotes to table Porcelain stoneware tiles, dry-pressed, Ströher Living ceramic tiles, garden and terrace slabs

¹⁾ Only applicable to dry pressed and extruded tiles with straight edges.

²⁾ Due to the firing process slight deviations from the respective standard colours are unavoidable. This does not affect deliberate irregularities of the colour nuances in the facial surface of dry pressed and extruded tiles (which may be unglazed, partly or fully glazed) and to the play of colours within a floor cladding, which is required and characteristic of the material concerned. Spots coloured specks, which have been intentionally applied for decorative reasons, should not be regarded as defects.

³⁾ Certain types of glaze may have a tendency to crazing. If the manufacturer draws attention to this, the test for crazing resistance according to Standard DIN EN ISO 10545-11 will not be applied.

⁴⁾ Slight colour changes should not be taken to indicate chemical attack.

SALES NATIONAL

General Manager Sales, Marketing & Product Management

Patrick Schneider
Tel.: +49 (0) 2771 391-0
Fax: +49 (0) 2771 391-223

Our general terms and conditions apply.
These can be accessed under www.stroeher.de

Lower Saxony, Eastern Westphalia, Bremen

Sales Representative
Frank Ginzel
Mobile: +49 (0) 170 5618975
Frank.Ginzel@stroeher.de

Back Office
Susanne Reeh
Tel.: +49 (0) 2771 391-227
Fax: +49 (0) 2771 391-364
Susanne.Reeh@stroeher.de

North Rhine-Westphalia, Lower Saxony

Sales Representative
Stefan Tenbrink
Mobile: +49 (0) 171 8610539
Stefan.Tenbrink@stroeher.de

Back Office
Sergio Ceniccola
Tel.: +49 (0) 2771 391-249
Fax: +49 (0) 2771 391-364
Sergio.Ceniccola@stroeher.de

Middle and Southern Hesse, North Rhine-Westphalia, Sauerland

Sales Representative
Frank Usner
Mobile: +49 (0) 171 8848190
Frank.Usner@stroeher.de

Back Office
Sergio Ceniccola
Tel.: +49 (0) 2771 391-249
Fax: +49 (0) 2771 391-364
Sergio.Ceniccola@stroeher.de

Rhineland-Palatinate, Eifel, Saarland, Baden-Wuerttemberg, Swabia

Sales Representative
Ina Altes
Mobile: +49 (0) 171 8848198
Ina.Altes@stroeher.de

Back Office
Eva Müller
Tel.: +49 (0) 2771 391-238
Fax: +49 (0) 2771 391-363
Eva.Mueller@stroeher.de

Back Office
Jörg André Dietermann
Tel.: +49 (0) 2771 391-208
Fax: +49 (0) 2771 391-363
Joerg-Andre.Dietermann@stroeher.de

Southern Bavaria, Allgäu, Upper Swabia

Sales Representative
Jürgen Wirner
Mobile: +49 (0) 171 8848199
Juergen.Wirner@stroeher.de

Back Office
Eva Müller
Tel.: +49 (0) 2771 391-238
Fax: +49 (0) 2771 391-363
Eva.Mueller@stroeher.de

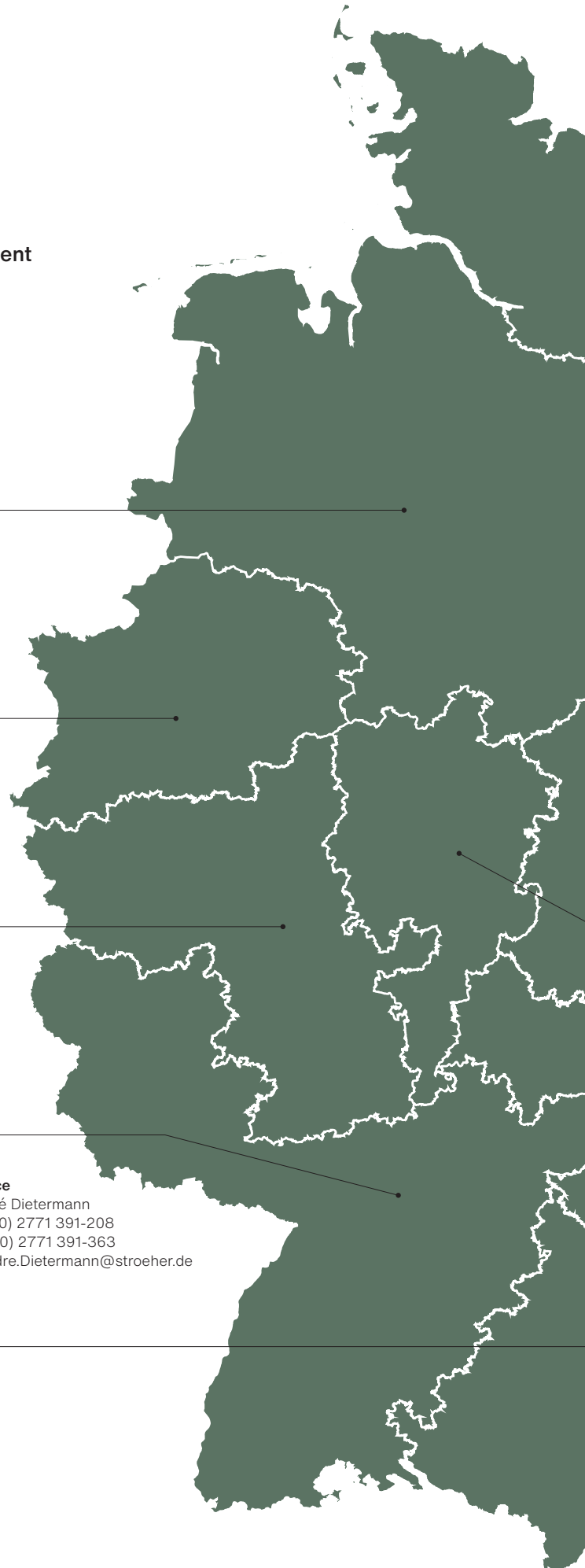

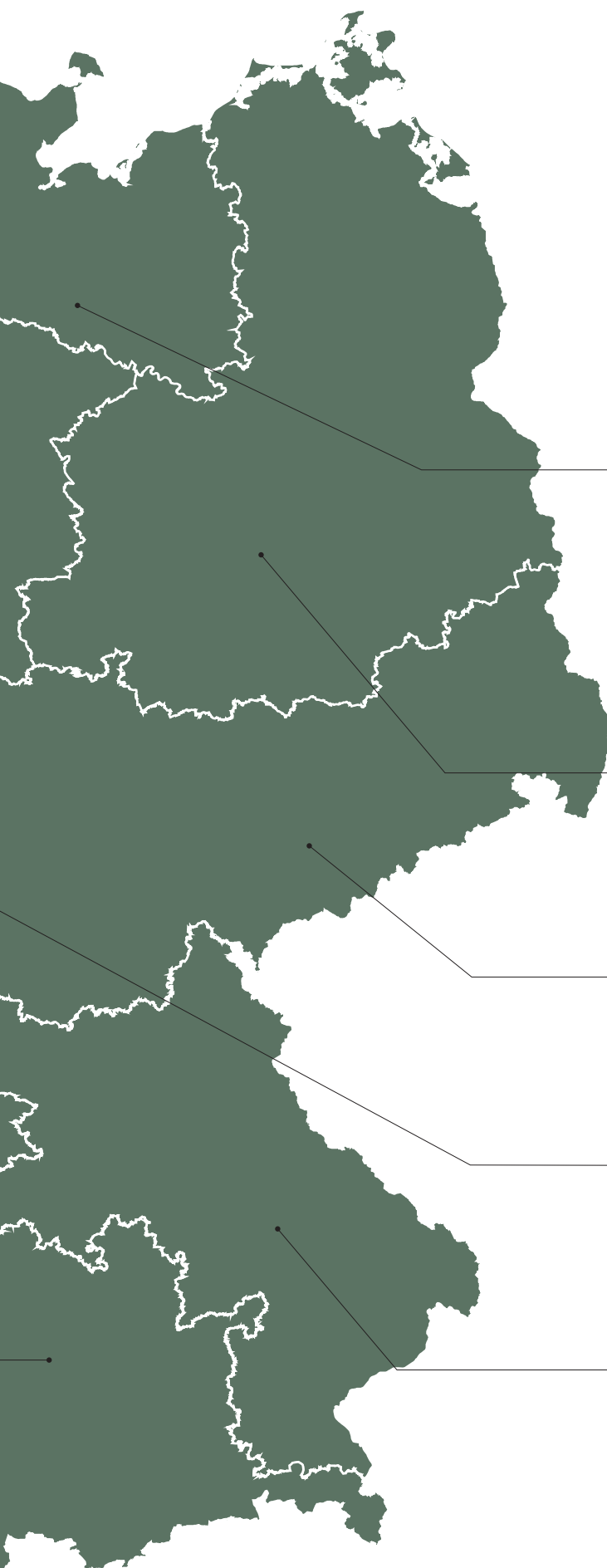

**Key Account Manager
Facade National**

KEY-ACCOUNT NORTH & EAST
Lower Saxony, Thuringia
Schleswig-Holstein, Berlin,
Mecklenburg-Western Pomerania,
Saxony-Anhalt, Saxony

Jörg Ruhdorf
Mobile: +49 (0) 171 8848180
Joerg.Ruhdorf@stroeher.de

KEY-ACCOUNT SOUTH
Baden-Wuerttemberg, Bavaria

Andreas Weber
Mobile: +49 (0) 151 22192533
Andreas.Weber@stroeher.de

**Key Account Manager
Project business National**

**Hesse, North Rhine-Westphalia,
Rhineland-Palatinate**

Peter Strödter
Mobile: +49 (0) 171 8848191
Peter.Stroedter@stroeher.de

Baden-Wuerttemberg, Bavaria

Robert Mock
Mobile: +49 (0) 171 8848197
Robert.Mock@stroeher.de

**Hamburg, Schleswig-Holstein,
Mecklenburg-Western Pomerania**

Sales Representative
Stefan Tenbrink
Mobile: +49 (0) 171 8610539
Stefan.Tenbrink@stroeher.de

Back Office
Sergio Ceniccola
Tel.: +49 (0) 2771 391-249
Fax: +49 (0) 2771 391-364
Sergio.Ceniccola@stroeher.de

**Berlin, Brandenburg, Mecklenburg-Western Pomerania,
Northern and Eastern Saxony-Anhalt**

Sales Representative
Knut Larsson
Mobile: +49 (0) 171 8848193
Knut.Larsson@stroeher.de

Back Office
Martin Tarfeld
Tel.: +49 (0) 2771 391-210
Fax: +49 (0) 2771 391-361
Martin.Tarfeld@stroeher.de

Thuringia, Southern Saxony-Anhalt, Saxony

Sales Representative
Knut Larsson
Mobile: +49 (0) 171 8848193
Knut.Larsson@stroeher.de

Back Office
Martin Tarfeld
Tel.: +49 (0) 2771 391-210
Fax: +49 (0) 2771 391-361
Martin.Tarfeld@stroeher.de

Northern and Eastern Hesse

Sales Representative
André Rustom
Mobile: +49 (0) 170 9331623
Andre.Rustom@stroeher.de

Back Office
Martin Tarfeld
Tel.: +49 (0) 2771 391-210
Fax: +49 (0) 2771 391-361
Martin.Tarfeld@stroeher.de

Northern-, Eastern- and Lower Bavaria

Sales Representative
Marco Pötzl-Garcia
Mobile: +49 (0) 171 8848189
Marco.Poetzl@stroeher.de

Back Office
Jörg André Dietermann
Tel.: +49 (0) 2771 391-208
Fax: +49 (0) 2771 391-363
Joerg-Andre.Dietermann@stroeher.de

SALES INTERNATIONAL



Head of Sales International

Peter Kraft
Tel.: +49 2771 391-232 · Mobile: +49 171 6467634
E-Mail: Peter.Kraft@stroehrer.de

Our general terms and conditions apply.
These can be accessed under www.stroehrer.de

Key Account Manager Facade Austria, Switzerland

Andreas Weber
Mobile: +49 151 22192533
Andreas.Weber@stroehrer.de

Country	Field Service		Back Office
Italy	Luca Bononcini Ströherstraße 2-10 35683 Dillenburg Germany	Mobile: +39 3488957344 E-Mail: Luca.Bononcini@stroehrer.de	Luca Bononcini Tel.: +49 2771 391-367 E-Mail: Luca.Bononcini@stroehrer.de
Austria	Bernhard Handelsagentur GmbH Waldstraße 12 2522 Oberwaltersdorf Austria	Tel.: +43 2253 60889 Mobile Günter Bernhard: +43 664 2095460 Mobile Sandra Bernhard: +43 664 4585380 E-Mail: office1@guenter-bernhard.at	Simone Hufnagel Tel.: +49 2771 391-213 E-Mail: Simone.Hufnagel@stroehrer.de
Switzerland	Uwe Eckert Handelsagentur Eckert GmbH Marktstraße 21 79771 Klettgau-Grießen Germany	Tel.: +49 7742 856777 Mobile: +49 173 6708538 E-Mail: info@eckert-keramik.de	Simone Hufnagel Tel.: +49 2771 391-213 E-Mail: Simone.Hufnagel@stroehrer.de
France	Peter Kraft Ströherstraße 2-10 35683 Dillenburg Germany	Tel.: +49 2771 391-232 E-Mail: Peter.Kraft@stroehrer.de	Valeria Müller-Isaak Tel.: +49 2771 391-398 E-Mail: Valeria.Mueller-Isaak@stroehrer.de
Belgium (Floor)	Cerovan BV Tom Vanlerberghe Kattebultkdreef 17 9880 Aalter Belgium	Tel.: +32 9 3752102 Mobile: +32 478 661342 E-Mail: tom@cerovan.be	Valeria Müller-Isaak Tel.: +49 2771 391-398 E-Mail: Valeria.Mueller-Isaak@stroehrer.de
Luxembourg	Ina Altes Ströherstraße 2-10 35683 Dillenburg Germany	Mobile: +49 171 8848198 E-Mail: Ina.Altes@stroehrer.de	Valeria Müller-Isaak Tel.: +49 2771 391-398 E-Mail: Valeria.Mueller-Isaak@stroehrer.de
Denmark, Norway and Sweden	Peter Kraft Ströherstraße 2-10 35683 Dillenburg Germany	Tel.: +49 2771 391-232 E-Mail: Peter.Kraft@stroehrer.de	Valeria Müller-Isaak Tel.: +49 2771 391-398 E-Mail: Valeria.Mueller-Isaak@stroehrer.de
Baltic States	Rolandas Stonkus Dubysos Str. 60 94107 Klaipėda Lithuania	Tel.: +370 61096371 E-Mail: info@msprimus.lt	Elena Gerhardt Tel.: +49 2771 391-397 E-Mail: Elena.Gerhardt@stroehrer.de
UK, Ireland	Peter Kraft Ströherstraße 2-10 35683 Dillenburg Germany	Tel.: +49 2771 391-232 E-Mail: Peter.Kraft@stroehrer.de	Elena Gerhardt Tel.: +49 2771 391-397 E-Mail: Elena.Gerhardt@stroehrer.de

Country	Field Service		Back Office
Czech Republic and Slovakia	"Klinkerstore" Luboš Duchek Průmyslová 1330 33441 Dobřany Czech Republic	Mobile: +420 608 690 950 E-Mail: lubos.duchek@klinkerstore.cz	Violetta Wloczyk Tel.: +49 2771 391-228 E-Mail: Violetta.Wloczyk@stroeher.de
Poland	Dipl. Ing. Przemysław Prochera Ul.Sienkiewicza 7 58-300 Wałbrzych Poland	Mobile: +48 500 120 806 E-Mail: p.prochera@eurobrick.pl	Violetta Wloczyk Tel.: +49 2771 391-228 E-Mail: Violetta.Wloczyk@stroeher.de
Russia	Andreas Manweiler Ströherstraße 2-10 35683 Dillenburg Germany	Tel.: +49 2771 391-369 Mobile: +49 151 14803062 E-Mail: Andreas.Manweiler@stroeher.de	Andreas Manweiler Tel.: +49 2771 391-369 E-Mail: Andreas.Manweiler@stroeher.de
Ukraine	Andreas Manweiler Ströherstraße 2-10 35683 Dillenburg Germany	Tel.: +49 2771 391-369 Mobile: +49 151 14803062 E-Mail: Andreas.Manweiler@stroeher.de	Andreas Manweiler Tel.: +49 2771 391-369 E-Mail: Andreas.Manweiler@stroeher.de
Kazakhstan, Kyrgyzstan, Uzbekistan, Tajikistan, Turkmenistan	Farid Gubaidullin	Tel.: +7 7710000888 E-Mail: Farid@asiaklinker.kz	Andreas Manweiler Tel.: +49 2771 391-369 E-Mail: Andreas.Manweiler@stroeher.de
Romania	Luca Bononcini Ströherstraße 2-10 35683 Dillenburg Germany	Mobile: +39 3488957344 E-Mail: Luca.Bononcini@stroeher.de	Luca Bononcini Tel.: +49 2771 391-367 E-Mail: Luca.Bononcini@stroeher.de
Bulgaria	COREL 67 EOOD Elin Dikov 47, Simeonovsko shosse Bul. 1700 SOFIA Bulgaria	Mobile: +359 888941653 E-Mail: elindikov@yahoo.co.uk	Elena Gerhardt Tel.: +49 2771 391-397 E-Mail: Elena.Gerhardt@stroeher.de
Hungary	Póth Klinker Petőfi S. u. 146. 2310 Szigetszentmiklos Hungary	Tel.: +36 24446670 E-Mail: info@pothklinker.hu	Violetta Wloczyk Tel.: +49 2771 391-228 E-Mail: Violetta.Wloczyk@stroeher.de
Greece	Tsobanoglou Kostas p.o. 712c Dimos Mikras 57500 Thessaloniki Greece	Tel.: +30 23920 73543 Mobile: +30 6944282129 E-Mail: tsobanoglou@gmail.com	Elena Gerhardt Tel.: +49 2771 391-397 E-Mail: Elena.Gerhardt@stroeher.de
United Arab Emirates, Qatar and Oman	Peter Utermann Faehrstr. 17 53757 Sankt Augustin Germany	Mobile: +49 172 2506545 E-Mail: utermann@hotmail.com	Luca Bononcini Tel.: +49 2771 391-367 E-Mail: Luca.Bononcini@stroeher.de
Asia	International Mercantile DMCC 3009, HDS Tower PO BOX 214798 JLT Dubai United Arab Emirates	Tel.: +34 670 382420 E-Mail: estesococonsulting@gmail.com	Luca Bononcini Tel.: +49 2771 391-367 E-Mail: Luca.Bononcini@stroeher.de
Overseas	Luca Bononcini Ströherstraße 2-10 35683 Dillenburg Germany	Mobile: +39 3488957344 E-Mail: Luca.Bononcini@stroeher.de	Luca Bononcini Tel.: +49 2771 391-367 E-Mail: Luca.Bononcini@stroeher.de



C
A
F
E



Follow us on social media



Instagram
@stroehergroup



YouTube
stroehergroup



Facebook
@StroeherGroup



LinkedIn
Ströher Group

Imprint

Errors and changes reserved.

The Ströher company supports the use of paper from sustainable forestry.

Paper used for this catalogue meets the ecological criteria for graphical paper.

Ströher® is a registered trademark of Ströher GmbH.

Ströherstraße 2-10, 35683 Dillenburg, www.stroeher.de

Concept, text and design: Ströher GmbH

© Ströher GmbH, 2023

Date: April 2023, Printed in Germany

THE
STRÖHER
GROUP.
SIGNATURE
CERAMICS
AND CLINKER.